

上海博众测量技术有限公司

Bodhi (Shanghai) measurement technology Co.,Ltd.  
NO.32,ShuPing Road, JiadingDistrict,ZIP201808,  
Shanghai R.P.China

TEL: 0086 21 6630 8161/62/63

FAX: 0086 21 6630 8167

# USER'S GUIDE

## Vaisala DRYCAP® Hand-Held Dewpoint Meter DM70



---

# Table of Contents

CHAPTER 1	
<b>GENERAL INFORMATION</b> .....	<b>6</b>
<b>Safety</b> .....	<b>6</b>
General Safety Considerations .....	6
<b>Feedback</b> .....	<b>6</b>
<b>Recycling</b> .....	<b>7</b>
<b>Trademarks</b> .....	<b>7</b>
<b>Warranty</b> .....	<b>8</b>
CHAPTER 2	
<b>PRODUCT OVERVIEW</b> .....	<b>9</b>
<b>Introduction to Vaisala DRYCAP® Hand-Held Dewpoint</b>	
<b>Meter DM70</b> .....	<b>9</b>
Basic Features and Options.....	10
Parts Description.....	11
CHAPTER 3	
<b>PREPARATIONS BEFORE USE</b> .....	<b>13</b>
<b>Installing and Removing the Battery Pack</b> .....	<b>13</b>
<b>Charging the Battery Pack</b> .....	<b>14</b>
<b>Buttons and Navigation</b> .....	<b>15</b>
<b>Turning on the Device</b> .....	<b>15</b>
CHAPTER 4	
<b>DEWPOINT MEASUREMENT</b> .....	<b>17</b>
<b>Measuring</b> .....	<b>17</b>
CHAPTER 5	
<b>USER INTERFACE</b> .....	<b>19</b>
<b>Basic Display</b> .....	<b>19</b>
<b>Menus</b> .....	<b>20</b>
<b>Display Menu</b> .....	<b>21</b>
Quantities and Units.....	21
Rounding.....	22
Hold/Save.....	23
Graphic History .....	23
<b>Functions Menu</b> .....	<b>24</b>
Alarm .....	24
Analog Output .....	26
Selecting and Scaling the Analog Output .....	26

Auto-Calibration.....	27
Automatic Auto-Calibration.....	27
Turning off Automatic Auto-Calibration .....	28
Manual Auto-Calibration.....	28
Sensor Purge.....	29
Turning on/off Automatic Sensor Purge .....	30
Changing Automatic Sensor Purge Interval .....	30
Manual Sensor Purge.....	31
Calibrate Transmitters (used only with DMP248).....	32
<b>Recording/Viewing Menu.....</b>	<b>32</b>
Recording Data.....	32
Stopping Recording.....	34
View Recorded Data .....	34
Memory Status .....	34
Clear Data Memory .....	35
Transferring Recorded Data to PC.....	35
<b>Environment Menu .....</b>	<b>36</b>
Pressure Settings .....	36
<b>Settings Menu .....</b>	<b>37</b>
User Interface .....	37
Language .....	37
Automatic Power Off .....	38
Program Shortcut Keys .....	38
Button Tones and Backlight .....	39
Date and Time .....	39
Measurement Settings .....	40
Automatic Auto-Calibration.....	40
Automatic Purge.....	40
Molecular Weight.....	40
Purge Interval .....	41
Device Information.....	41
Factory Settings.....	42

CHAPTER 6

<b>FIELD CALIBRATION CHECK OF FIXED TRANSMITTERS .....</b>	<b>43</b>
Field Calibration Check of DMT340/DMT242/DMT142 .....	43
Field Calibration Check of DMP248 .....	44

CHAPTER 7

<b>SAMPLING FROM PROCESSES .....</b>	<b>47</b>
<b>Sampling Cells .....</b>	<b>48</b>
DSC74 .....	48
DSC74B.....	49
DSC74C .....	49
DMT242SC.....	52
DMT242SC2.....	52
<b>Connection to Pressurized Processes Using the DSC74</b>	
<b>Sampling Cell .....</b>	<b>52</b>
<b>DSS70A Sampling System.....</b>	<b>54</b>
DSS70A Sampling Procedure .....	55
DSS70A Maintenance .....	56
Recharging the Battery.....	56

Changing the Battery .....	57
Changing the Filter.....	59
Changing the Fuses.....	60

CHAPTER 8

<b>MEASURING MOISTURE IN SF<sub>6</sub> GAS-INSULATED EQUIPMENT .....</b>	<b>61</b>
<b>Overview .....</b>	<b>61</b>
Operating Environment .....	62
Measuring.....	62

CHAPTER 9

<b>CALIBRATION, ADJUSTMENT, AND MAINTENANCE.....</b>	<b>65</b>
<b>Calibration.....</b>	<b>65</b>
User Calibration and Adjustment .....	65
Adjusting DM70.....	66
Adjusting DMT340 Series Transmitters Using DM70 as Reference or Terminal .....	66
<b>Adjusting Dewpoint.....</b>	<b>67</b>
Two-Point Relative Humidity Adjustment.....	67
Two-Point Relative Humidity Adjustment of DMT340 Series Transmitters Using DM70 .....	68
Adjusting Dewpoint T <sub>d/f</sub> .....	70
T <sub>d/f</sub> Adjustment of DM70.....	70
T <sub>d/f</sub> Adjustment of DMT340 Series Transmitters using DM70.....	71
To Same as T <sub>d/f 1/11</sub> .....	72
1-Point Adjustment.....	73
<b>Adjusting Temperature .....</b>	<b>74</b>
Temperature Adjustment of DM70 .....	74
One-Point Adjustment.....	74
Two-Point Adjustment.....	75
Temperature Adjustment of DMT340 Series Using DM70 .	75
To Same as T <sub>1/11</sub> .....	76
1-Point Adjustment.....	76
2-Point Adjustment.....	77
<b>Vaisala Service Centers.....</b>	<b>78</b>

CHAPTER 10

<b>DE-COMMISSIONING, DISMANTLING, AND DISPOSAL .....</b>	<b>79</b>
--	-----------

CHAPTER 11

<b>TECHNICAL SPECIFICATIONS.....</b>	<b>81</b>
<b>Measured Variables.....</b>	<b>81</b>
Dewpoint Temperature.....	81
Temperature.....	83
PPM (ppm <sub>v</sub> or ppm <sub>w</sub> ).....	83
Absolute Humidity (DMP74A Probe Recommended) ....	84
Mixing Ratio (DMP74A Probe Recommended) .....	84
Relative Humidity (DMP74A) .....	84
Measurement Environment.....	84
Probe General.....	85

MI70 Indicator.....	85
Indicator General.....	85
Battery Pack.....	86
DMP74 Probe + MI70 Indicator = Vaisala DRYCAP® DM70	
Hand-Held Dewpoint Meter.....	86
General.....	86
Electromagnetic Compatibility.....	87
Sampling Cells.....	87
DMT242SC Sampling Cell.....	87
DMT242SC2 Sampling Cell with Swagelok	
Connectors.....	87
DSC74 Sampling Cell for Pressurized Gases.....	87
DSC74B Two-Pressure Sampling Cell.....	87
DSC74C.....	88
DMCOIL.....	88
DSS70A Sampling System.....	88
Accessories.....	89
Dimensions.....	90

## List of Figures

Figure 1	Hand-Held Dewpoint Meter DM70.....	11
Figure 2	Installing the Battery Pack.....	13
Figure 3	Buttons.....	15
Figure 4	Basic Display.....	19
Figure 5	Menus.....	21
Figure 6	Quantities and Units Menu.....	22
Figure 7	Alarm.....	24
Figure 8	Analog Output.....	26
Figure 9	Auto-Calibration Displays.....	29
Figure 10	Sensor Purge Displays.....	31
Figure 11	Calibrate Transmitters Display.....	32
Figure 12	Recording.....	32
Figure 13	Environment Menu.....	36
Figure 14	User Interface.....	37
Figure 15	Hold/Save Replaced by Auto Cal.....	39
Figure 16	Measurement Settings Menu.....	40
Figure 17	Device Information.....	41
Figure 18	Indicator and Probe Information.....	42
Figure 19	Calibrate Transmitters Message.....	45
Figure 20	DSC74 Sampling Cell with the Adapters.....	48
Figure 21	DSC74B.....	49
Figure 22	Default Assembly of DSC74C.....	50
Figure 23	Alternative Assembly of DSC74C for Tight Spaces.....	51
Figure 24	DMT242SC and DMT242SC2 Sampling Cells.....	52
Figure 25	DM70 with the Case.....	55
Figure 26	Lifting the System.....	57
Figure 27	Sampling System Upside Down.....	58
Figure 28	Changing the Filter.....	59
Figure 29	Gas Collection Option.....	62
Figure 30	Removing the Leak Screw.....	63
Figure 31	DMP74A Accuracy.....	82
Figure 32	DMP74B Accuracy.....	82
Figure 33	DMP74C Accuracy.....	82
Figure 34	Dimensions in Millimeters (Inches).....	90

---

## List of Tables

Table 1	Measurement Intervals and Maximum Recording Times.....	33
Table 2	List of Accessories .....	89

## Recycling



Recycle all applicable material.



Dispose of batteries and the unit according to statutory regulations.  
Do not dispose of with regular household refuse.

## Trademarks

DRYCAP<sup>®</sup> is a registered trademark of Vaisala. Microsoft<sup>®</sup>, Windows<sup>®</sup>, and Windows NT<sup>®</sup> are registered trademarks of Microsoft Corporation in the United States and/or other countries.

## Warranty

Vaisala hereby represents and warrants all Products manufactured by Vaisala and sold hereunder to be free from defects in workmanship or material during a period of twelve (12) months from the date of delivery save for products for which a special warranty is given. If any Product proves however to be defective in workmanship or material within the period herein provided Vaisala undertakes to the exclusion of any other remedy to repair or at its own option replace the defective Product or part thereof free of charge and otherwise on the same conditions as for the original Product or part without extension to original warranty time. Defective parts replaced in accordance with this clause shall be placed at the disposal of Vaisala.

Vaisala also warrants the quality of all repair and service works performed by its employees to products sold by it. In case the repair or service works should appear inadequate or faulty and should this cause malfunction or nonfunction of the product to which the service was performed Vaisala shall at its free option either repair or have repaired or replace the product in question. The working hours used by employees of Vaisala for such repair or replacement shall be free of charge to the client. This service warranty shall be valid for a period of six (6) months from the date the service measures were completed.

This warranty is however subject to following conditions:

- a) A substantiated written claim as to any alleged defects shall have been received by Vaisala within thirty (30) days after the defect or fault became known or occurred, and
- b) The allegedly defective Product or part shall, should Vaisala so require, be sent to the works of Vaisala or to such other place as Vaisala may indicate in writing, freight and insurance prepaid and properly packed and labelled, unless Vaisala agrees to inspect and repair the Product or replace it on site.

This warranty does not however apply when the defect has been caused through

- a) normal wear and tear or accident;
- b) misuse or other unsuitable or unauthorized use of the Product or negligence or error in storing, maintaining or in handling the Product or any equipment thereof;
- c) wrong installation or assembly or failure to service the Product or otherwise follow Vaisala's service instructions including any repairs or installation or assembly or service made by unauthorized personnel not approved by Vaisala or replacements with parts not manufactured or supplied by Vaisala;
- d) modifications or changes of the Product as well as any adding to it without Vaisala's prior authorization;
- e) other factors depending on the Customer or a third party.

Notwithstanding the aforesaid Vaisala's liability under this clause shall not apply to any defects arising out of materials, designs or instructions provided by the Customer.

This warranty is expressly in lieu of and excludes all other conditions, warranties and liabilities, express or implied, whether under law, statute or otherwise, including without limitation any implied warranties of merchantability or fitness for a particular purpose and all other obligations and liabilities of Vaisala or its representatives with respect to any defect or deficiency applicable to or resulting directly or indirectly from the Products supplied hereunder, which obligations and liabilities are hereby expressly cancelled and waived. Vaisala's liability shall under no circumstances exceed the invoice price of any Product for which a warranty claim is made, nor shall Vaisala in any circumstances be liable for lost profits or other consequential loss whether direct or indirect or for special damages.



## CHAPTER 2

# PRODUCT OVERVIEW

## Introduction to Vaisala DRYCAP<sup>®</sup> Hand-Held Dewpoint Meter DM70

DM70 measures dewpoint temperature accurately in a measurement range from -60 °C up to +60 °C depending on the probe version. DM70 incorporates the advanced DRYCAP<sup>®</sup> technology, which enables reliable and high-performance dewpoint measurement. DM70 measures the following quantities:

- dewpoint/frost point<sup>1)</sup> temperature  $T_{d/f}$  (°C/°F)
- dewpoint temperature<sup>2)</sup>  $T_d$  (°C/°F)
- temperature  $T$  (°C/°F)
- dewpoint/frost point in the atmospheric pressure  $T_{d/f}$  (°C atm/°F atm)
- dewpoint in the atmospheric pressure  $T_d$  (°C atm/°F atm)
- relative humidity RH (%)
- humid air /dry air H<sub>2</sub>O ppm<sub>v</sub>/ppm<sub>w</sub>
- absolute humidity  $a$  (g/m<sup>3</sup>)
- mixing ratio  $x$  (g/kg)

<sup>1)</sup>  $T_{d/f}$  shows the dewpoint temperature above the freezing point (0 °C/32 °F) and frost point temperature  $T_f$  (dewpoint over ice) below the freezing point. This is considered as the industry standard.

<sup>2)</sup>  $T_d$  shows the dewpoint over water throughout the entire measurement range.

DM70 consists of two main units: the MI70 indicator and DMP74 probe, versions A, B, or C. DM70 can be used with the optional sampling cell to measure process dewpoint. With DSS70A, DM70 forms a part of a complete portable sampling system for measuring process dewpoint.

## Basic Features and Options

DM70 has the following basic features and options:

- Numerical and graphical multilingual displays.
- Data recording possibility.
- A tool for checking the reading of the fixed transmitters DMT340, DMP248, DMT242 and DMT142
- A possibility for an analog output (voltage signal 0 ... 1 V)
- An optional, ready-to-use Microsoft Windows<sup>®</sup> software, which allows an easy way to handle measurement data using a serial line or a USB instrument cable
- The optional sampling system DSS70A (see section DSS70A Sampling System on page 54)

## Parts Description

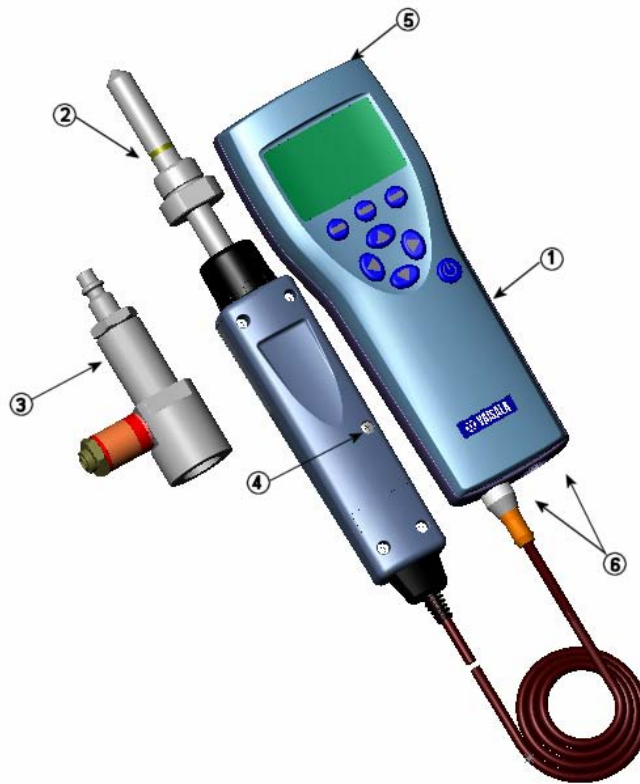

0403-031

**Figure 1** Hand-Held Dewpoint Meter DM70

The following numbers refer to Figure 1 above.

- 1 = MI70 indicator
- 2 = DMP74 probe
- 3 = Sampling cell DSC74 (optional)
- 4 = Calibration button
- 5 = Recharger connector
- 6 = Connector ports for probes and cables

This page intentionally left blank.

## CHAPTER 3

**PREPARATIONS BEFORE USE****Installing and Removing the Battery Pack****NOTE**

If you have previously used a battery pack, put the metal contact at the lower end of the batteries before installing the alkaline batteries.

If DM70 is ordered with a battery pack, it is already installed at the factory.

1. Unscrew the back plate of the indicator.
2. Remove the old batteries. Detach the black connector by pulling it up carefully from the wires.

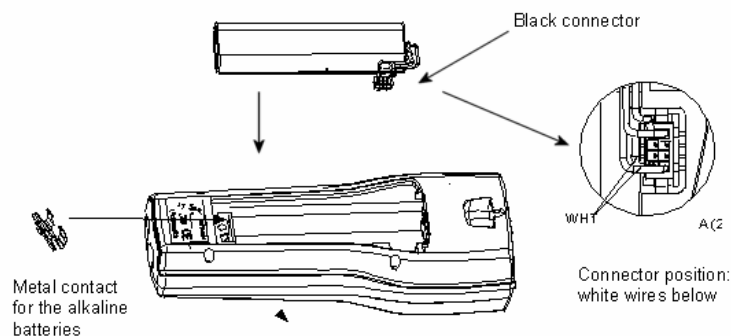

0403-032

**Figure 2 Installing the Battery Pack**

3. Connect the black connector of the new battery pack. Make sure the red and black wires are on the upper edge of the connector.

Do not push the connector with any conducting material. See Figure 2 on page 13.

**NOTE**

If you have previously used alkaline batteries, remove the metal contact before installing the battery pack.

4. Replace the battery pack, close the back plate, and tighten the screw.
5. Charge the battery before use.

**NOTE**

Old batteries must be disposed of according to the local laws and regulations.

## Charging the Battery Pack

**NOTE**

Do not use DM70 during the first charging.

1. Plug the recharger connector to the base of the indicator.
2. Connect the recharger to a wall socket. A battery symbol in the corner of the display will start rolling.
3. When the battery symbol stops rolling, the battery pack is fully charged.
4. Disconnect the recharger.

The duration of recharging is typically 4 hours. However, the recommended first charging time is 6 hours.

## Buttons and Navigation

To turn on the device, press the **Power On/Off** button. To open menus, press an arrow button and then press the shortcut buttons. To activate a function shown above the shortcut button, press the shortcut button. To navigate in the menus, press arrow buttons.

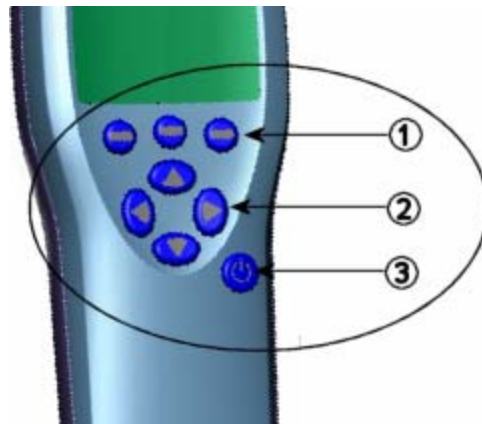

0403-033

**Figure 3 Buttons**

The following numbers refer to Figure 3 above.

- 1 = Shortcut buttons
- 2 = Arrow buttons
- 3 = Power on/off button









## Turning on the Device

1. Connect the probe to either one of the base connectors in the indicator.
2. Press the **Power On/Off** button.
3. Press any of the arrow buttons and open a menu by pressing **Open**.
4. Select **Settings** using the **▲▼** buttons and press **▶**.
5. Select **User interface** and press **▶**.
6. Select **Language** and press **⊖ Set**.
7. Select the language using the **▲▼** buttons. Confirm the selection by pressing **⊖ Select**.

8. If you want to set the date at this point, return to the **Settings** menu by pressing .

**NOTE**

The language can be selected also later. See section Language on page 37.

9. To change the date, select **Date** and press  **Set**. Then change the date using the   buttons. To confirm the selection, press  **Select**. As a default, the date format is year-month-day. You can select from two other alternative formats.
10. To change the time, select **Time** and press  **Set**. Then change the time by using the arrow buttons. Confirm the selection by pressing  **OK**. As a default, the time format is based on the 24-hour clock. If you want to use the 12-hour clock, select **12-hour clock** and then press  **On**.
11. To return to the basic display, press  **Exit**.



## CHAPTER 4

# DEWPOINT MEASUREMENT

The following recommendations should be taken into account when measuring in very dry environments.

- A clean environment is always best for humidity measurements.
- The number of connections should be minimized to avoid leaks.
- The flow rate must be adequate.
- Dead ends must be avoided as they cannot be flushed easily.
- The tube temperature must never lie under the dewpoint of the sample gas. This may lead to condensation and false results.
- The sample tubing should be of as short length as possible. The surface area should be minimized using the narrowest tubing that the flow conditions allow.
- The surface finish of the pipework is important. Polished or electro-polished steel is recommended for best results.
- Hygroscopic materials should be avoided in the sampling lines. Use stainless steel membranes instead of rubber membranes.
- Impermeable materials should be selected to avoid inward diffusion of moisture through the sampling tubes and enclosures. Such impermeable materials are, for example, high-quality stainless steel and metals. Avoid PVC or nylon tubes.

## Measuring

If you start DM70 for the first time, see section Preparations Before Use on page 13. Otherwise, follow the instructions below.

1. Connect the probe to the MI70 indicator.
2. Press the **Power On/Off** button.

3. Install the probe to the measuring position. If you are measuring in pressurized processes, see section Connection to Pressurized Processes Using the DSC74 Sampling Cell on page 52. When using other sampling cells than DSC74, make sure that the threads are compatible with the probe threads (G ½" ISO228/1). Be careful not to damage the sintered filter when installing the probe.
4. Before measuring, make sure that the air pressure settings of DM70 are correct and that auto-calibration has taken place (see section Automatic Auto-Calibration on page 27)
5. The basic display opens. Let the reading stabilize.

**CAUTION**

If you need to disconnect the probe from the indicator, first press the **Power On/Off** button to turn the indicator off. This ensures that all the settings and data are saved properly.

**NOTE**

When measuring low dewpoints, the stabilization times can be long, for example, one to two hours. Therefore, turn off the automatic power-off function (see section Automatic Power Off on page 38), turn on the automatic auto-calibration (see section Automatic Auto-Calibration on page 27), and turn on the automatic sensor purge (see section Turning on/off Automatic Sensor Purge on page 30).

Thus, the stabilization can be monitored, the auto-calibration ensures an accurate measurement, and the purge ensures the shortest possible response times.

## CHAPTER 5

# USER INTERFACE

This chapter contains information that is needed to operate this product.

## Basic Display

When DM70 is turned on, the display shown in Figure 4 below appears.

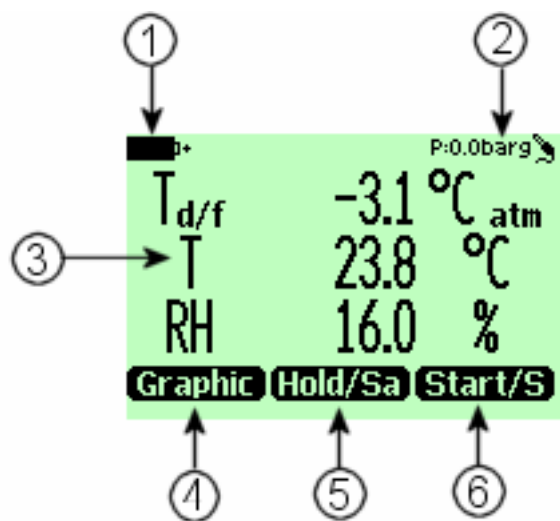

0403-034

**Figure 4 Basic Display**

The following numbers refer to Figure 4 above.





- 1 = The state of the battery.
- 2 = Pressure settings.

- 3 = Selected quantities. Up to three of the following quantities can be selected at a time: dewpoint ( $T_{d/f}$ ,  $T_d$ ), relative humidity (RH), absolute humidity (a), mixing ratio (x), parts per million ( $H_2O$ ), temperature (T).
- 4 = The **Graphic**<sup>1)</sup> shortcut button changes the display into a curve mode.
- 5 = The **Hold/Sa**<sup>1)</sup> shortcut button holds the display and allows you to save the reading into the memory.
- 6 = The **Record** shortcut button takes you to the **Recording/Viewing** menu. This is the default shortcut button. In the figure it has been changed to **Start/S**.

<sup>1)</sup> The **Graphic**, **Hold/Sa**, and **Record** functions above the shortcut buttons are set at the factory. You can change them to refer to other functions as shown in Figure 4 on page 19 where **Start/S** has replaced **Record**. See also section Program Shortcut Keys on page 38.

## Menus

The settings can be changed and functions can be selected in the menus. Follow the instructions below:

1. Open the main menu by pressing one of the  buttons.
2. Press  **Open** within 5 seconds. Otherwise, the basic display returns. If this happens, start from step 1 again.
3. Move in the menus using the  buttons.
4. Select an item with the  button.
5. To return to the previous level, press .
6. To return to normal operation, press **Exit**.

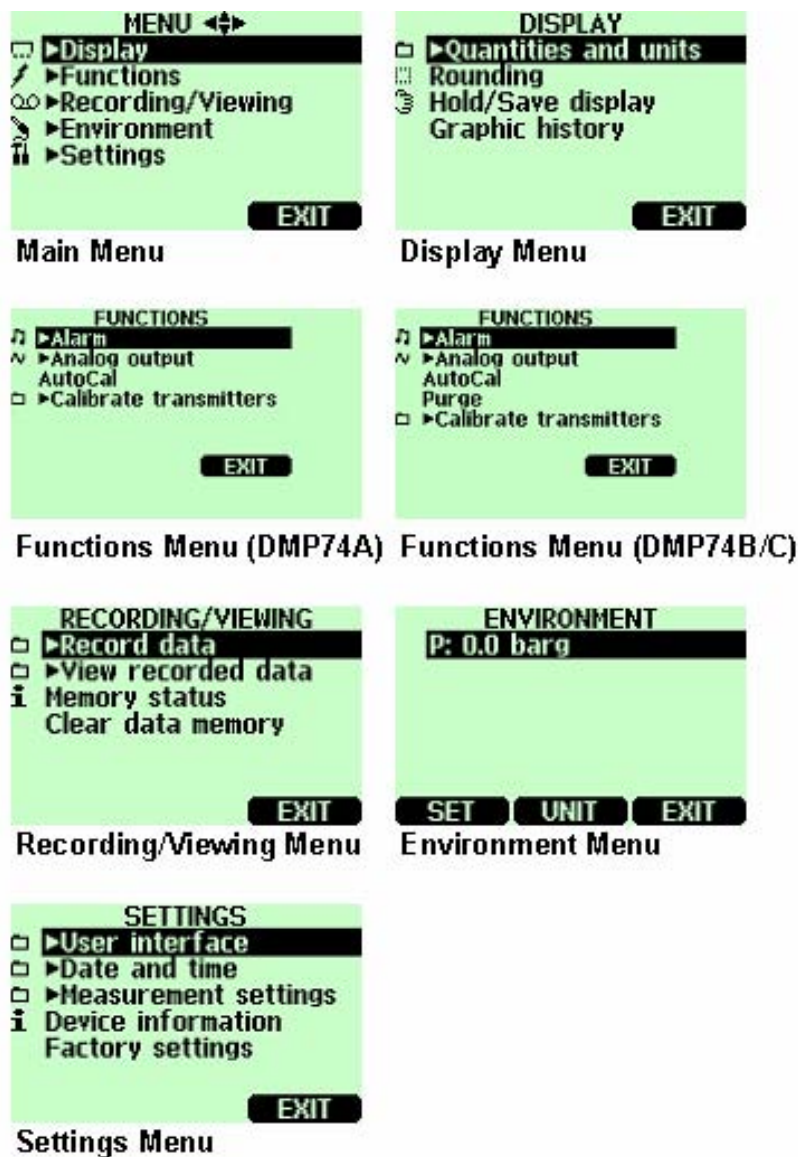

0403-035

Figure 5 Menus

## Display Menu

### Quantities and Units

You can select 1 ... 3 display quantities at a time. The unit of quantities ( $T_{d/f}$ ,  $T_d$ , or  $T$ ) can be selected between °C or °F. The default is °C.

To select a quantity, do the following:

1. Open the menu by pressing **▶** **⊖** **Open**.
2. Select **■** **Display** and press **▶**.
3. Select **■** **Quantities and units** and then press **▶**.
4. To select a quantity, move on the desired quantity using the arrow buttons and then press **⊖** **Select**.
5. To change the unit, move on the desired quantity using the arrow buttons and then press **⊖** **Unit** (°C or °F).
6. To hide a quantity, move on the desired quantity using the arrow buttons and then press **⊖** **Hide**.
7. To return to the basic display, press **⊖** **Exit**.
8. If you want to check the environment settings, press **⊖** **Yes**. Otherwise press **⊖** **No**.

**NOTE**

Units °C atm and °F atm indicate that the dewpoint or frost point is converted from process pressure to atmospheric pressure.

Below you will find an example of the **Quantities and Units** menu.

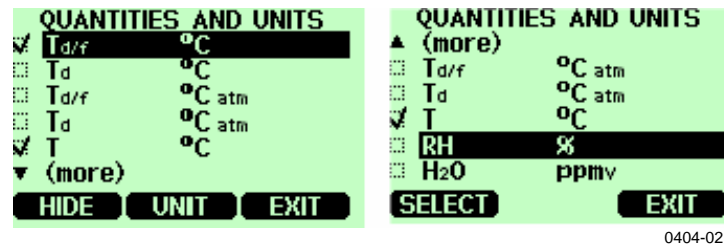



0404-021

Figure 6 Quantities and Units Menu

## Rounding

You can select a one- or two-decimal display using **Rounding**. As a default, rounding is turned off (=a two-decimal display is in use).

1. Open the menu by pressing **▶** **⊖** **Open**.
2. Select **■** **Display** and then press **▶**.
3. Select **Rounding**.















4. To turn rounding on (=a one-decimal display), press  **On**. To turn rounding off (=a two-decimal display), press  **Off**.
5. To return to the basic display, press  **Exit**.

**NOTE**

Rounding does not affect the measurement accuracy. Accuracy is defined in Chapter 11 on page 81.

## Hold/Save

With the **Hold/Save** function you can hold a selected display reading and save it into the memory. Several readings can be saved. The reading saved first is called data point 1, the second saved reading is called data point 2, and so on. All the individual readings (data points) are stored in the same file marked with . The file will remain in the indicator memory even when the indicator is switched off.

1. Open the menu by pressing   **Open**.
2. Select  **Display** and then press .
3. Select **Hold/Save display**.
4. To hold the display, press  **Hold**. The measurement data is displayed.
5. To save the reading, press  **Save**. To return to the basic display, press  **Exit**.
6. To view the saved readings, press   **Record** in the basic display. Then select  **View recorded data** and press .
7. Select the file marked with  and press . Now you can view the saved data readings. To view the recording time stamps, press  **Times**.
8. To return to the basic display, press  **Exit**.

## Graphic History

The graphical display shows the measurements as a curve. From the curve, you can examine the data trend and history of the last minutes.

The graphical display shows the curve of the uppermost quantity shown in the basic display.

1. Open the menu by pressing **▶ ◀ Open**.
2. Select **Display** and press **▶**.
3. To go to the **Graphical history** display, select **Graphic history** and press **◀ Show**.
4. To get the statistical info on the graph area (minimum, maximum, and average values), press **◀ Info**.
5. To get the curve of the other selected quantities, press **◀ Next**. To get the curves of all the quantities, press **◀ Next** until the text ALL appears on the display. Then press **◀ All**.
6. To zoom in a curve, press **▲**. To zoom out, press **▼**. To move the curve horizontally, press **▶ ◀**.
7. To return to the basic display, press **◀ Back** and **Exit**.

## Functions Menu

### Alarm

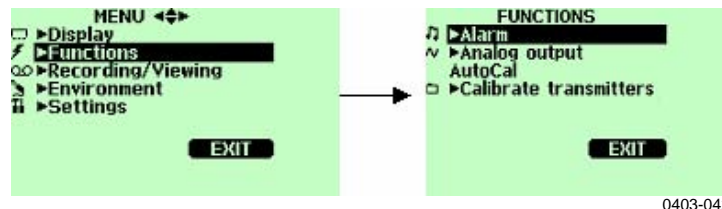

Figure 7 Alarm

When the alarm goes off, DM70 beeps and the backlight blinks. The alarm is turned on when the measured value is not between the alarm limits, that is, the permitted area. The alarm level(s) can be set for only one quantity at a time. To set the alarm levels, follow the instructions below:

1. Open the menu by pressing **▶ ◀ Open**.
2. Select **Functions** and press **▶**.
3. Select **Alarm** and press **▶**.



4. Select **Quantity** and press  $\ominus$  **Set** to select the quantity.
5. Select the quantity and press  $\ominus$  **Select**. Only one active quantity can be selected at a time. To change which quantities are active, go to **Menu** -  $\blacktriangleright$  **Display** -  $\blacktriangleright$  **Quantities and units**.
6. Select the first limit and press  $\ominus$  **Set** (if the alarm function is on, turn it off). Use the arrow buttons to set the alarm level. To select the sign for the alarm level, press the  $\ominus$  +/- button. To save the settings, press  $\ominus$  **OK**.
7. Select the second limit and follow the instructions in step 6. The alarm will go off when either the upper or lower limit is exceeded.

If you will use only one limit, for example, if you want to detect if the dewpoint will rise above -40 °C, do the following:

Set the upper limit to -40 °C and the value of the lower limit so low that it will never be reached, for example, to -80 °C. Thus, DM70 will alert when  $T_d$  rises above -40 °C.

8. To activate the alarm and to return to the basic display, select **Alarm On/Off** and press  $\ominus$  **On**. The note symbol  $\text{⌘}$  will appear in the upper left corner of the display.
9. When the alarm level is reached, you can stop the alarm by pressing  $\ominus$  **OK**. To reactivate the alarm, press  $\ominus$  **Yes**. To completely stop the alarm, press  $\ominus$  **No**.

**NOTE**

The alarm does not work when the device is turned off.

# Analog Output

## Selecting and Scaling the Analog Output

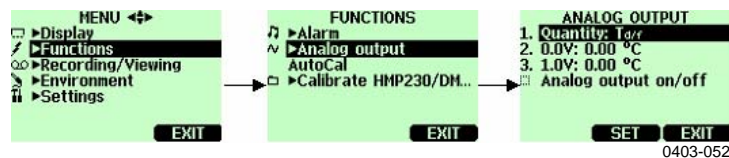

**Figure 8** Analog Output

To get analog measurement data, an analog signal cable is needed (see section Accessories on page 89).

1. Connect the signal cable connector of the analog output to the base connector of the indicator. Connect the screw terminal block as follows:

Brown wire: common wire (-)  
Yellow-green wire: signal (+)

2. Open the menu by pressing **▶ ◀** **Open**.
3. Select **▶ Functions** and press **▶**.
4. Select **▶ Analog output** and press **▶**.
5. Select **Quantity** and press **◀** **Set**.
6. Select **Quantity** and press **◀** **Select**. Only one active quantity can be selected at a time. To change the quantities, go to **Menu - ▶ Display - ▶ Quantities and units**.
7. To set the value for the 0.0 V output signal, select **0.0 V** and press **◀** **Set**. If the analog output is on, turn it off. Set the low value using the arrow buttons. To select the sign for the value, press **◀** **+/-**.
8. To set the value for the 1.0 V output signal, select **1.0 V** and press **◀** **Set**. Set the high value using the arrow buttons. To select the sign for the value, press **◀** **+/-**. To confirm the setting, press **◀** **OK**.
9. To activate the analog output and to return to the basic display, select **Analog output on/off** and press **◀** **On**. The following symbol ~ appears in the upper left corner of the basic display.

10. To deactivate analog output, go to **Menu - Functions - Analog output - Analog output on/off** and press **Off**.

## Auto-Calibration

To obtain the best possible accuracy in measurements taken in dry environments, DM70 has a built-in, automatic calibration. During the auto-calibration, DM70 adjusts the dry-end reading to correspond to the calibrated values. This is a unique and patented method to avoid errors in accuracy when monitoring low dewpoints.

The auto-calibration is carried out if the following criteria for the measurement environment are fulfilled:

- Relative humidity must be <5 % (DMP74A).  
<2 % (DMP74B/C).
- Temperature must be  $0 < T < 60$  °C.
- Humidity environment must be stable. The maximum change in the dewpoint can be 1 °C within 30 seconds.

### NOTE

Auto-calibration cannot operate if the above conditions are not fulfilled.

If the adjustment in the auto-calibration reaches a preset, maximum value or if the auto-calibration correction fails, for example, because of unstable conditions, a new auto-calibration may take place later (if the automatic auto-calibration is turned on). Auto-calibration can be either automatic or manual.

### Automatic Auto-Calibration









As a default, the automatic auto-calibration in DM70 is turned on. In this mode, the calibration takes place automatically if the dewpoint or temperature changes significantly, typically more than 10 °C. However, if there are no changes in the conditions, the calibration will take place at an interval of one hour or at least, after one hour from the last auto-calibration.

## Turning off Automatic Auto-Calibration

**NOTE**





If the automatic auto-calibration is turned off, the auto-calibration should be started when starting measuring after the probe has not been used for a while and always at least once every hour.

The automatic auto-calibration can be turned off as follows:

1. Open the menu by pressing   **Open**.
2. Select  **Settings** and press .
3. Select  **Measurement settings** and press .
4. To turn off the automatic auto-calibration, press  **Off**. To reactivate the automatic auto-calibration, press  **On**.
5. To return to the basic display, press  **Exit**.

## Manual Auto-Calibration

To check that auto-calibration has taken place for obtaining the most accurate measurement in a very dry environment, you can auto-calibrate manually before measuring as follows:

1. Open the menu by pressing   **Open**.
2. Select  **Functions** and press .
3. Select **AutoCal** and press  **Start**.
4. If you want to start auto-calibration, press **Yes**. If the auto-calibration conditions are not fulfilled, a note appears on the display informing that the calibration cannot be made or that a new attempt will be made later.
5. When the auto-calibration is completed, the display returns to the basic display automatically.

Auto-calibration takes about 2 minutes. When the auto-calibration is in progress, an estimate of the measurement readings may appear on the display. Messages concerning the remaining auto-calibration time are shown periodically. See Figure 9 on page 29.

**NOTE**

If it is too humid, auto-calibration will not start.

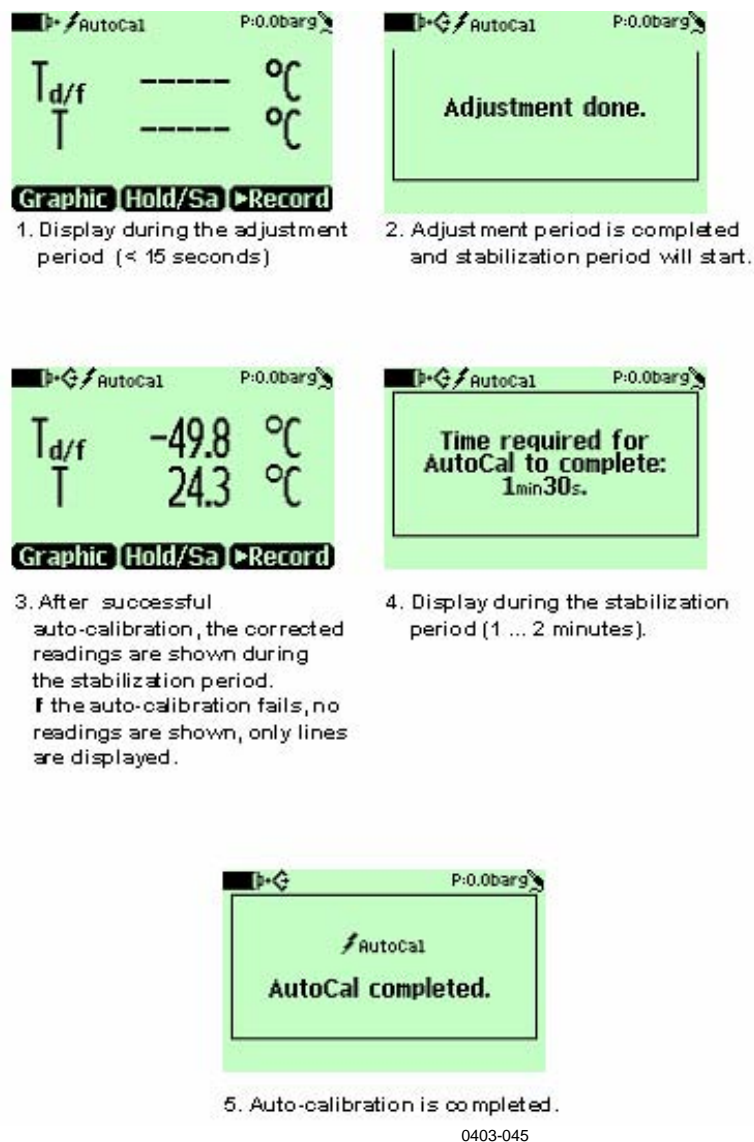

**Figure 9** Auto-Calibration Displays

## Sensor Purge

Sensor purge feature is only available in the DMP74B/C probe. The purge should be carried out to achieve the shortest response times and the best long-term stability.

Sensor purge is an automatic procedure, in which the sensor is dried. Thus, the sensor will response very fast when installing the probe from an ambient to a dry gas. This will also ensure together with auto-calibration the best measurement accuracy and long-term stability.

The purge is performed automatically if humidity changes significantly or quickly and if the dewpoint is low enough.











As a default, the automatic sensor purge is turned on automatically in DM70. It is recommended not to turn it off. The automatic sensor purge can also be started manually, which is necessary if the purge has not been performed during the last 24 hours. If the power is continuously turned on in DM70, or if DM70 has been left in logging mode (display on or off), the automatic sensor purge will be performed at set interval (default = 24 hours).

### Turning on/off Automatic Sensor Purge

**NOTE**





When the sensor purge is performed on a regular basis, the measurement will have the best accuracy and fastest response time. Perform the sensor purge when starting measuring after the probe has been stored and always at least once every 24 hours.

The automatic sensor purge can be turned on or off as follows:

1. Open the menu by pressing   **Open**.
2. Select  **Settings** and press .
3. Select  **Measurement settings** and press .
4. Select  **Autom.Purge** and press .
5. To turn the automatic sensor purge off, press  **Off**. To reactivate the automatic sensor purge, press  **On**.
6. To return to the basic display, press  **Exit**.

### Changing Automatic Sensor Purge Interval

If there are high chemical concentrations present in the measurement environment, it may cause some sensor drift. If you experience this kind of drift, it may be necessary to perform the sensor purge more often. The purge interval can be varied between 1 ... 48 hours. Note however, that more frequent sensor purge will reduce battery operation time.

1. Open the menu by pressing   **Open**.
2. Select  **Settings** and press .

3. Select **Measurement settings** and press  $\blacktriangleright$ .
4. Select **Purge interval** and press  $\ominus$  **Set**.
5. Set the desired purge interval with the arrow buttons. Press  $\ominus$  **OK** to confirm.
6. To return to the basic display, press  $\ominus$  **Exit**.

### Manual Sensor Purge

To check that the sensor purge has been performed to ensure the best possible response times or before calibration, start the purge manually as follows:

#### NOTE

Although the sensor purge is in the automatic mode, it can also be performed manually.

1. Open the menu by pressing  $\blacktriangleright$   $\ominus$  **Open**.
2. Select **Functions** and press  $\blacktriangleright$ .
3. Select **Purge** and press  $\ominus$  **Start**. Confirm the selection by pressing **Yes**.
4. When the sensor purge is completed, the display returns to the basic display automatically. The stabilization of the temperature reading can take a few minutes.

#### NOTE

If the dewpoint is low, automatic auto-calibration will take place immediately after the sensor purge.

The purge will take up to 5 minutes to complete. During the purge, there are no readings on the display. A message appears on the display every 15 seconds to inform of the time required to complete the purge. The purge symbol also appears in the upper left corner of the display. See Figure 10 on page 31.

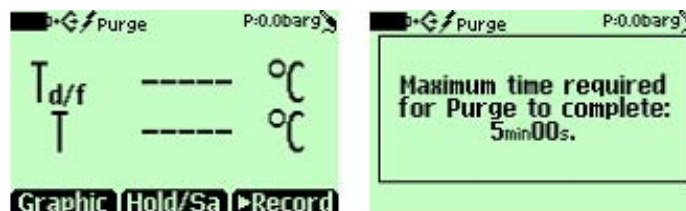

Display during the first minute. Note message.

0403-044

**Figure 10** Sensor Purge Displays

You can also change one of the shortcut keys to refer to the sensor purge. See section Program Shortcut Keys on page 38.

## Calibrate Transmitters (used only with DMP248)

In this menu, you can set the baud rate, serial format, and start calibration. For details, refer to Chapter 6, Field Calibration Check of Fixed Transmitters, on page 43.

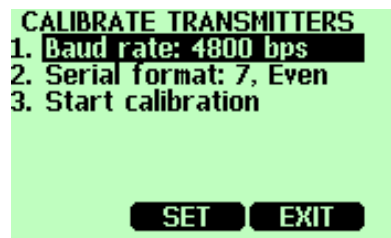

Figure 11 Calibrate Transmitters Display

## Recording/Viewing Menu

### Recording Data

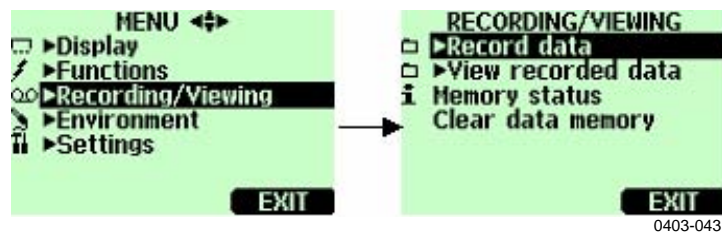



Figure 12 Recording

You can record measurement data and view it on the display. Do the following:





1. Press **Record** or open the menu and select **Recording/Viewing**.
2. Select **Record data** and press **Enter**.



3. To change the recording interval, select **Interval** and press  **Set**.
4. Select the measurement interval with the arrow buttons. The measurement intervals and the maximum recording times are shown in Table 1 on page 33.

**Table 1 Measurement Intervals and Maximum Recording Times**

Measure-ment Interval	Maximum Recording Time (Memory Full)		
	1 quantity	2 quantity	3 quantity
1 s	45 min	22 min	15 min
5 s	3 h	113 min	75 min
15 s	11 h	5 h	3 h
30 s	22 h	11 h	7 h
1 min	45 h	22 h	15 h
5 min	9 days	4 days	3 days
15 min	28 days	14 days	9 days
30 min	56 days	28 days	18 days
1 h	113 days	56 days	37 days
3 h	339 days	169 days	112 days
12 h	1359 days	678 days	451 days

5. Press  **Select**.
6. To set the duration of the recording, select **Duration** and then press  **Set**. Select the duration with the arrow buttons and press  **Set**.
7. To start recording, select **Start/Stop recording**, press  **Start**. If you choose Memory full, you will see the maximum recording time on the display. You can also delete files to empty the memory. To accept the maximum recording time, press  **Start** again.
8. You can switch off DM70 during recording to save the battery. A message will appear on the display to inform that recording will continue undisturbed even when the power is turned off. If the indicator is switched off during recording, the progress bar is shown on the display every 10 seconds (continuously if the charger is connected). The bar indicates the amount of recorded data.

### CAUTION

Do not disconnect the probe when the data recording is on, even if the indicator is turned off. This may cause loss of recorded data.

## Stopping Recording

1. To stop recording, press **Record**.
2. Select **Record data** and press .
3. Then select **Start/Stop recording** and press **Stop**.
4. To view the recorded file, select **Show**.

## View Recorded Data

1. Open the menu by pressing **Open**.
2. Select **Recording/Viewing** and press .
3. Select **View recorded data** and press .
4. Select the file you want to view and press . The files are identified according to the starting date and time of recording.
5. To go to the graphical view, press **Graph**. To view the recording time stamps, press **Times**. To return to the recording values, press **Values**.
6. To return to the basic display, press **Exit**.

## Memory Status

You can check the memory status as follows:

1. Open the menu by pressing **Open**.
2. Select **Recording/Viewing** and press .
3. To view the amount of memory that is in use and the estimated free space left, select **Memory status** and press **Show**.
4. To return to the basic display, press **OK** and **Exit**.

### NOTE

The estimate of available free space is calculated for the current number of active quantities. If you change the displayed quantities, the estimate will change accordingly.

## Clear Data Memory

The data memory can be cleared as follows:

1. Open the menu by pressing **▶ ⊖ Open**.
2. Select **Recording/Viewing** and press **▶**.
3. Select **Clear data memory** and press **⊖ Clear**. To confirm the deletion, press **⊖ Yes**.
4. To return to the basic display, press **⊖ Exit**.

## Transferring Recorded Data to PC

The recorded data can be transferred to a PC using the MI70 Link program. The MI70 Link program can be ordered from Vaisala, see section Accessories on page 107. You can examine the recorded data easily in the Microsoft Windows® environment and transfer it further on a spreadsheet program, such as, Microsoft Excel® for modifications. Together with the USB instrument cable (optional accessory 219687) or the serial connection cable it is easy to transfer logged and real time measurement data from the DM70 to a PC.

When using the USB cable consider the following: the MI70 Link program contains the driver needed for the USB connection. For the system requirements and installation, see the back of the installation CD. Follow the installation instructions on the CD. Check that the USB cable is not connected. The MI70 Link Setup Wizard will install Vaisala MI70 Link on your computer. Installing the USB instrument driver can take a few minutes. After the installation is finished, connect the USB cable to the USB port on your PC. Windows will detect the new device, and use the driver automatically.

You can now start monitoring the DM70 readings in real time with a PC using the MI70 Link program. In case the MI70 Link cannot find the instrument, check the following:

- the DM70 is switched on
- the USB instrument cable/serial connection cable is properly connected to the USB/serial port of your PC
- another application has not reserved the connection

## Environment Menu

### Pressure Settings

In pressurized environments, the actual process pressure value must be set for DM70. The pressure can be given in the following units:

- $P_{\text{barg}}$ : Gauge pressure is given in the unit of bar. It indicates the pressure difference between the normal atmospheric pressure and the actual process pressure.
- $P_{\text{bara}}$ : Absolute process pressure is given in the unit of bar.
- $P_{\text{psig}}$ : Gauge pressure is given in the unit of psi. It indicates the pressure difference between the normal atmospheric pressure and the actual process pressure.
- $P_{\text{psia}}$ : Absolute pressure is given in the unit of psi.

To set the values, follow the instructions below:

1. Open the menu by pressing  $\rightarrow$   $\ominus$  **Open**.
2. Select **Environment** with  $\uparrow$   $\downarrow$  and then press  $\rightarrow$ . See Figure 13 below.



0403-036

**Figure 13 Environment Menu**

3. To change the pressure unit, press  $\ominus$  **Unit**. The default unit is barg.
4. To set the ambient pressure value, press  $\ominus$  **Set**.
5. Set the value using the  $\uparrow$   $\downarrow$   $\rightarrow$   $\leftarrow$  buttons. To change the sign of the pressure value, press  $\ominus$  +/- . To save the value, press  $\ominus$  **OK**.
6. To return to the basic display, press  $\ominus$  **Exit**.

# Settings Menu

## User Interface



Figure 14 User Interface

## Language

You can select any of the following languages for the user interface: English, Finnish, Chinese, Russian, Japanese, Swedish, French, German, or Spanish.

To select the language, follow the instructions below:









1. Open the menu by pressing **▶ ◀** **Open**.
2. Select **Settings** and then press **▶**.
3. Select **User interface** and then press **▶**.
4. Select **Language** and press **◀** **Set**.
5. Then select the desired language and press **◀** **Select**.
6. To return to the basic display, press **◀** **Exit**.

If you accidentally selected a language you do not want, follow the instructions below:

1. Return to the basic display by pressing the rightmost **◀** until the basic display appears.
2. Go to the **Language selection** menu by pressing first **▶** and then the **◀** button in the middle.
3. Then press **▲**, then **▶**, then **▶** again and finally press again the **◀** button in the middle.
4. Reselect the language.









## Automatic Power Off

As a default, the power in DM70 is automatically turned off after 15 minutes of inactivity. This also saves the battery. The inactivity settings can be changed to 60 minutes or completely turned off. See the instructions below:

1. Open the menu by pressing   **Open**.
2. Select  **Settings** and press .
3. Select  **User interface** and press .
4. Select **Auto power off** and press  **Set**.
5. Select the inactivity time and press  **Select**.
6. To return to the basic display, press  **Exit**.

## Program Shortcut Keys

As a default, the three shortcut keys refer to **Graphic**, **Hold/Save**, and  **Start/S** functions. You can change any of the shortcut keys to refer to functions that better suit your needs. See the instructions below:

1. Open the menu by pressing   **Open**.
2. Select  **Settings** and press .
3. Select  **User interface** and press .
4. Select **Program shortcut keys** and then press  **Start**.
5. Press the shortcut key you want to change, for example, **Hold/Save**.
6. If you want to replace the **Hold/Save** with the auto-calibration function, select **AutoCal** with the arrow buttons and then press  **Select**. To confirm your selection, press **Yes**. Otherwise press **No** and continue from step 4.
7. To return to the basic display, press  **Exit**

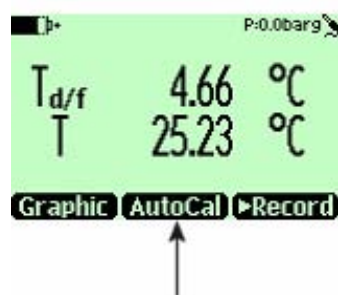

0403-039

**Figure 15 Hold/Save Replaced by Auto Cal**

## Button Tones and Backlight

You can turn on or off the sound effects for the buttons and the back light. Follow the instructions below:

1. Open the menu by pressing **▶ ◀ Open**.
2. Select **Settings** and press **▶**.
3. Select **User interface** and press **▶**.
4. To turn on or off the sound effect, select **Key Click** and then press **◀ On/Off**.
5. To turn on or off the backlight, select **Backlight on key** and press **◀ On/Off**.
6. To return to the basic display, press **◀ Exit**.

## Date and Time

As a default, the time format is based on the 24-hour clock. Also a 12-hour clock can be used.

The default date format is day.month.year, for example, 25.4.2004. The date format can be changed to month.day.year. or year.month.day.

For correct time and date in the recorded data files, follow the instructions below:

1. Open the menu by pressing **▶ ◀ Open**.
2. Select **Settings** and press **▶**.

3. Select **Date and time** and press  $\odot$ .
4. For the desired date, select **Date** and then press  $\ominus$  **Set**. Use the arrow buttons to change the date. Confirm the selection by pressing  $\ominus$  **Select**. To change the date format, select from the alternatives and press  $\ominus$  **Select**.
5. For the desired time, select **Time** and press  $\ominus$  **Set**. Use the arrow buttons to change the time. To confirm the selection, press  $\ominus$  **OK**. To change the time format, select **12-hour clock** and press  $\ominus$  **On/Off**.
6. To return to the basic display, press  $\ominus$  **Exit**.

## Measurement Settings

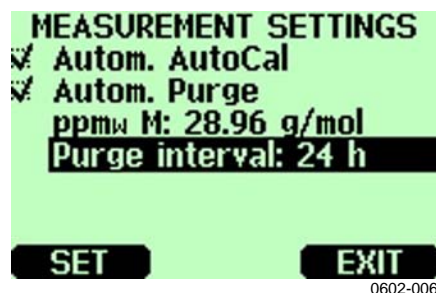

Figure 16 Measurement Settings Menu

### Automatic Auto-Calibration

To turn the feature on, press  $\ominus$  **On**. To turn the feature off, press  $\ominus$  **Off**.

### Automatic Purge

To turn the feature on, press  $\ominus$  **On**. To turn the feature off, press  $\ominus$  **Off**.

### Molecular Weight

The **ppm<sub>w</sub> M** setting is used to give the molecular weight of the measured gas. This value is required in ppm<sub>w</sub> (weight) calculation.



The default values are 28.96 for DMP74A/B (air) and 146.06 for DMP74C (SF6).

## Purge Interval

The time interval at which the automatic sensor purge is performed can be changed between 1 ... 48 hours. For instructions, refer to section Changing Automatic Sensor Purge Interval on page 30.

## Device Information

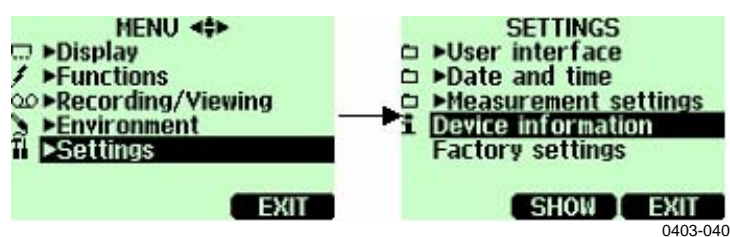

**Figure 17** Device Information

Basic information about the indicator and the probe is found as follows:

1. Open the menu by pressing **Open**.
2. Select **Settings** and press **Enter**.
3. Select **Device information** and press **Show**.
4. The first display gives the information on the MI70 indicator. For details on the probe, press **More** and then press **OK**. See Figure 18 below.
5. To return to the basic display, press **Exit**.

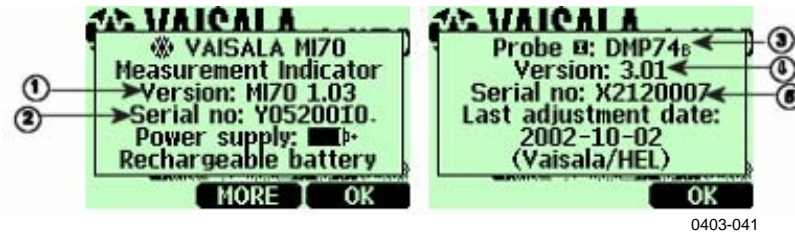

**Figure 18 Indicator and Probe Information**

The following numbers refer to Figure 18 above.

- 1 = Software version of the MI70 indicator
- 2 = Serial number of the MI70 indicator
- 3 = Probe type
- 4 = Software version of the probe
- 5 = Serial number of the probe

## Factory Settings

The factory settings can be restored to clear all the changed settings and data memory of the indicator. Restoring factory settings does not affect the probe calibration.

1. Open the menu by pressing **▶ ◀ Open**.
2. Select **Settings** and press **▶**.
3. Select **Factory settings** and press **◀ Revert**. To confirm the selection, press **◀ Yes**. Power is turned off automatically.

When turning on DM70 again, the factory settings are restored. You will have to set the language, date, and time again.

## CHAPTER 6

# FIELD CALIBRATION CHECK OF FIXED TRANSMITTERS

To compare measurement readings or to read the output of a fixed transmitter directly on the DM70 display, connect DM70 to a fixed Vaisala transmitter using the connection cable accessories.

Vaisala DRYCAP® Dewpoint and Temperature Transmitter Series DMT340 can be adjusted in laboratory conditions using DM70 as a reference. Please refer to Chapter 9, Calibration, Adjustment, and Maintenance on page 65 for more information.





## Field Calibration Check of DMT340/DMT242/DMT142

You can use DM70 to display the reading of DMT340, DMT242 or DMT142 and to compare the readings of DM70 and DMT340/DMT242/DMT142.

To connect DMT340 you need connection cable 211339. For DMT242, you will need the 27160ZZ cable and for DMT142, you will need the 211917ZZ cable (see section Accessories on page 89).

For field calibration check, follow the instructions below.

1. Turn off DM70.
2. Connect the cable between DMT340 (service port) or DMT242/DMT142 (serial port) and DM70 (connector I or II). Turn on both the devices.

3. If you are requested to check the environment settings, press  **Yes**. Then check the pressure settings. To set the ambient pressure, see section Pressure Settings on page 36.
4. Check that the pressure units of DM70 and DMT340/DMT242/DM142 are the same.  
  
If not, and you are checking DMT242/DMT142, change the DM70 pressure unit to **bara** by pressing  **Unit** on the corresponding row. You cannot change the pressure unit for DMT242/DMT142. Then adjust the values as instructed in section Pressure Settings on page 36.  
  
When using DM70 to check DMT340, you can change the pressure unit of DMT340 by pressing  **Unit** on the corresponding row. It is also possible to change the pressure unit of DMT340 through the transmitters local display/keypad interface, for instructions, please refer to the DMT340 User's Guide. Then adjust the values as instructed in section Pressure Settings on page 36.
5. When the pressure settings are correct, press  **Exit**. Now the display shows the dewpoint readings  $T_{d/f}$  of DM70, DMT340/DMT242/DMT142, and the difference between the readings  $\Delta T_{d/f}$ . Roman numerals (I and II) after the quantity abbreviations indicate from which port the readings are coming. You can follow the measurement trend from the graphical display.
6. Wait until the readings are stabilized. It can take up to one hour in very low dewpoints. If the difference between the dewpoint readings is less than 3 °C, there is no immediate need for adjustment. However, in applications where optimum accuracy is essential, it is recommended to send the DMT340/DMT242/DMT142 transmitter to Vaisala (see section Vaisala Service Centers on page 78) when the difference is considered significant.
7. Press the **Power On/Off** button.
8. Disconnect the connection cable.

## Field Calibration Check of DMP248

You can use DM70 to display the readings of DMP248 and to compare readings of DM70 and DMP248. To make the connection, you will need the 27159ZZ cable. See section Accessories on page 89.

1. Connect the cable between DMP248 (connector X5, 6-pin connector on the left of the motherboard) and DM70 (connector I or II). Turn on both the devices.
2. Open the menu by pressing **▶ ◀ Open**.
3. Select **▀ Functions** and press **▶**.
4. Select **▀ Calibrate transmitters** and press **▶**.
5. Select **1. Baud rate** and **2. Serial format**. To change the serial settings, press **◀ Set**. The serial settings of DMP248 and DM70 must be the same. As a default, the DMP248 serial settings are 4800 bps, 7 Even.
6. Select **3. Start calibration** and press **◀ Start**. If the serial settings of DM70 are not compatible with the settings of DM248, or the cable connection is not working, the following message appears:

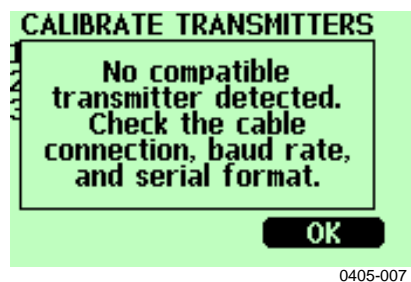

**Figure 19 Calibrate Transmitters Message**

Check that the serial settings of DMP248 and the settings of DM70 are the same. Check the cable connection. Then retry from step 6.

7. After the connection has been established, press **◀ OK**.
8. Select the quantity to check ( $T_d$  or  $T$ ) and press **◀ Select**.
9. Check the environment settings of the DM70 probe, if needed. Press **◀ Yes** or **◀ No**.
10. The measurement value of DMP248 is shown on the upper row and the value of DM70 on the second row. The third row shows the difference between the measurements of DMP248 and DM70.

11. Wait until the readings are stabilized (can take one hour in very low dewpoints). If the difference between the dewpoint readings is less than 3 °C, there is no immediate need for adjustment. However, in applications where best possible accuracy is essential, it is recommended to send the DMP248 transmitter to Vaisala (see section Vaisala Service Centers on page 78) if the difference is considered significant.
12. To return to the basic display, press  **Exit**.

## CHAPTER 7

# SAMPLING FROM PROCESSES

When the dewpoint of a process needs to be measured using DM70, the process can be sampled using one of the following devices:

- DSC74
- DSC74B
- DSC74C
- DSS70A
- DMT242SC
- DMT242SC2

Use the DSC74 sampling cell when the sample is taken from the pressurized process, where the process pressure forces the sample gas into the sample cell.

Use the DSC74B sampling cell as DSC74. DSC74B is enhanced version of DSC74. With version B, harmful gases can be recovered.

DSC74C complements DSC74B with a diffusion coil, which allows measuring in the atmospheric pressure.

Use the DSS70A sampling system when the process is not pressurized, that is, the sample must be pumped from the process and when the process is dirty or too hot for direct measurements.

Use the DMT242SC sampling cell when only the body (thread 3/8"G and 1/4"G) of the main sampling cell is needed.

Use the DMT242SC2 sampling cell with the welded Swagelok connectors. This is ideal for sampling in a 1/4" pipeline.

## Sampling Cells

### DSC74

- sampling cell with a leakage screw, thread 3/8"G
- quick coupling, type NIP08, type D
- thread adapter, type 3/8" - 1/4"G
- thread adapter, type 3/8" - 1/2"G (for DMP248 and DMT242 fittings)

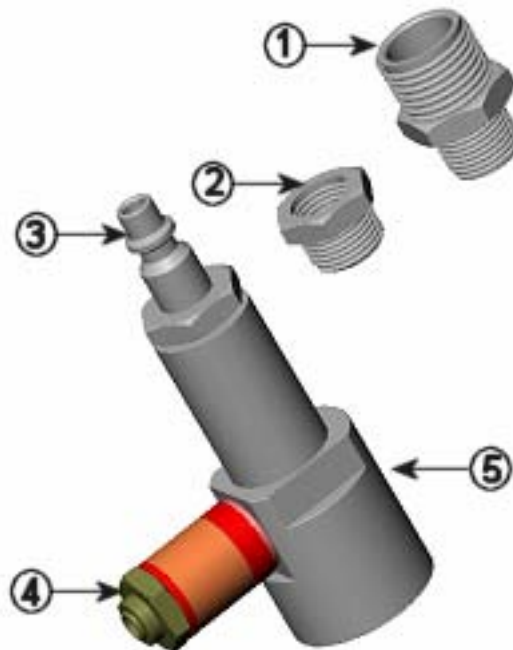

0403-047

**Figure 20 DSC74 Sampling Cell with the Adapters**

The following numbers refer to Figure 20 above.

- 1 = Thread adapter type 3/8" - 1/2"G
- 2 = Thread adapter type 3/8" - 1/4"G
- 3 = NIP08, type D
- 4 = Leakage screw
- 5 = Sampling cell DSC74



## DSC74B

- sampling cell, thread 3/8"G
- connection part with a needle valve and an integrated leakage screw
- Reducing Nipple (thread adapter), 3/8"G - 1/2"G
- Reducing Adapter (thread adapter), 3/8"G - 1/4"G

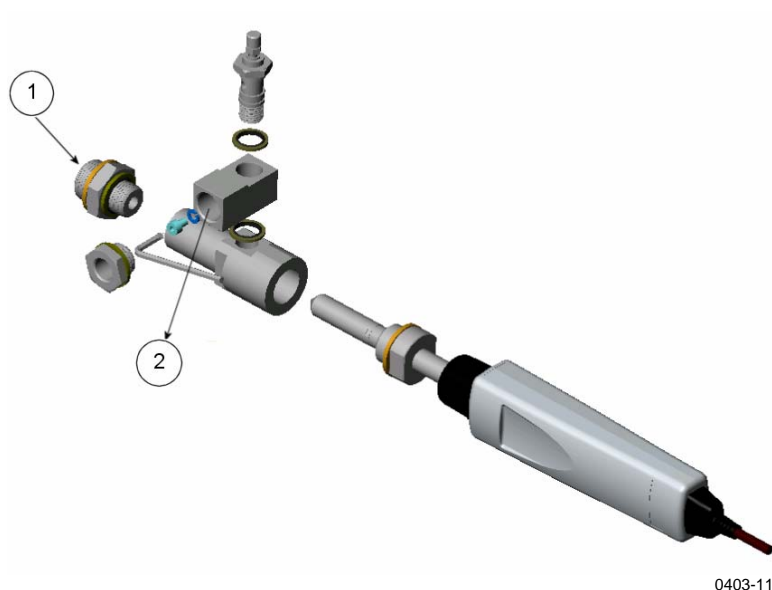

**Figure 21 DSC74B**

The following numbers refer to Figure 21 above.

- 1 = Gas goes in
- 2 = Gas comes out

## DSC74C

- sampling cell, thread 3/8"G
- connection part with a needle valve and an integrated leakage screw
- Reducing Nipple (thread adapter), 3/8"G - 1/2"G
- Reducing Adapter (thread adapter), 3/8"G - 1/4"G
- diffusion coil (for measurements in atmospheric pressure)

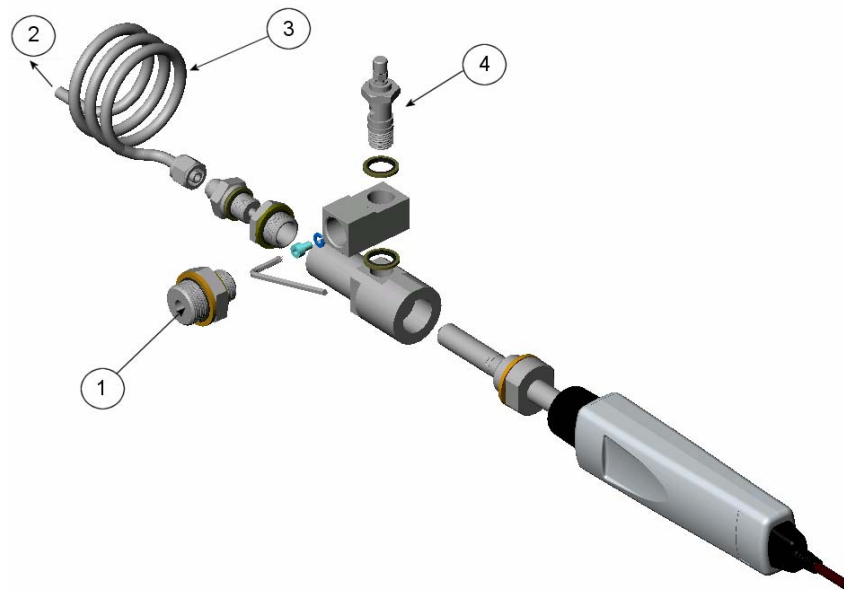

0403-112

**Figure 22 Default Assembly of DSC74C**

The following numbers refer to Figure 22 above.

- 1 = Gas goes in. Also the coil can be used here.
- 2 = Gas comes out
- 3 = Coil
- 4 = Valve

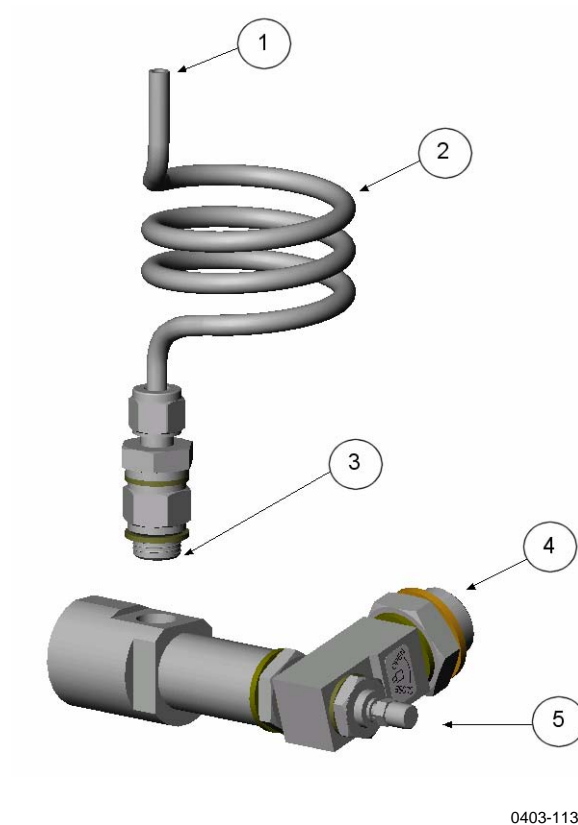

**Figure 23** Alternative Assembly of DSC74C for Tight Spaces

The following numbers refer to Figure 23 above.

- 1 = Gas comes out
- 2 = Coil
- 3 = Thread, max. size 7 mm
- 4 = Gas goes in
- 5 = Valve

The thread size cannot exceed 7 mm. Use the provided adapter to avoid damage to the probe.

## DMT242SC

DMT242SC is a sampling cell with threads 3/8"G and 1/4"G. See Figure 24 on page 52.

## DMT242SC2

DMT242SC2 is a sampling cell with 1/4" welded Swagelok connectors. See Figure 24 below.



0405-013

Figure 24 DMT242SC and DMT242SC2 Sampling Cells

## Connection to Pressurized Processes Using the DSC74 Sampling Cell

DSC74 is a Vaisala sampling cell for connecting DM70 to the pressurized processes (See section Accessories on page 89). With DSC74B and DSC74C measuring can be done in overpressure or atmospheric pressure. This depends on whether the sample gas is let into the sample cell before the needle valve or after that. See Figure 21 on page 49 and Figure 22 on page 50.

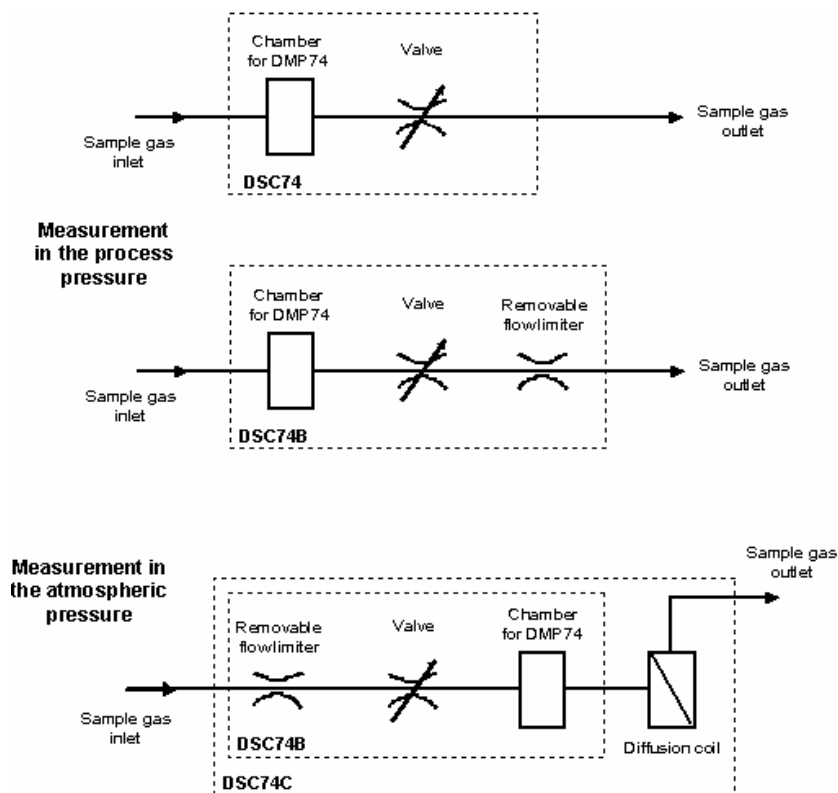

To make the connection, follow the instructions below:

1. Select the quick connector or thread adapter according to your process fitting.
2. Check that the pressure setting is correct. For details, see section Pressure Settings on page 36.
3. Make sure that the valve of the sampling cell is open. First close the valve, then turn it halfway open again. You can also first open the valve more to ventilate the parts, then readjust it to allow only a small leakage.
4. Carefully seal the threads of the quick connector or thread adapter with the PTFE thread seal tape.
5. Attach the quick connector or thread adapter onto the sample cell threads. Tighten the fitting with a fork spanner.
6. Connect the sample cell to the process fittings. Seal the fitting with the PTFE thread seal tape.
7. Install the gasket (delivered with the probe) to the nut of probe thread.

8. Set the probe into the sample cell. Tighten the probe by turning it from the thread nut. Do not tighten the probe from the handle.
9. If the sample cell is installed correctly, there is no leakage in the connections. You can test this by closing the valve temporarily.

**CAUTION**

By using the quick connector, the process pressure can be maintained during the installation or removal of the sampling cell. Take a firm hold of the device to keep it in your hands while removing it. When the thread adapters are used, the process pressure has to be shut down for the installation or removal of the probe.

## DSS70A Sampling System

DSS70A is a sampling system for taking gas samples from hot, dirty, or pressurized processes. The gas collecting system is built in the briefcase including the DM70 meter. The system consists of a sample pump that draws out the sample gas, a filter to clean the sample from particles (> 7 $\mu$ m), and a sample valve and flowmeter to adjust the flow rate.

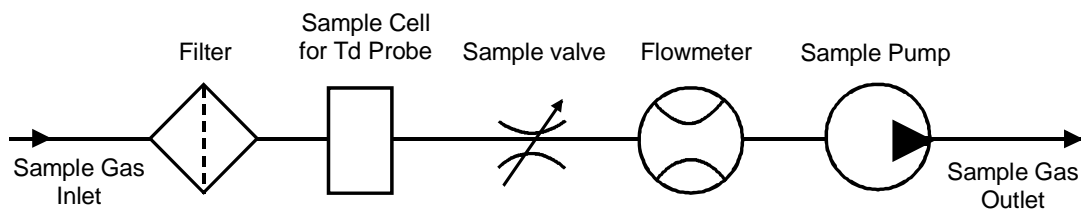

The sample gas going into the system must meet the following requirements:

- The temperature must be <40 °C (104 °F). Thus, when using the FEP tube of 2 meters (provided), the temperature of the process gas should be less than 200 °C (392 °F). When the temperature of the sample gas is over 200 °C, a stainless steel tube (not provided) should be used.
- The sample gases must be: Air, N<sub>2</sub>, non-toxic gases, inert, non-flammable gases.
- If the sample is taken from a pressurized process (1.2 ... 20 bar), the sample pump must be turned off and the tube from the flowmeter to the pump must be detached.

The DSS70A sampling system can be ordered from Vaisala separately or in connection with the Vaisala DRYCAP® Hand-Held Dewpoint Meter DM70.



**Figure 25** DM70 with the Case

The following numbers refer to Figure 25 on page 55.

- 1 = Fuses
- 2 = Inline filter (7  $\mu\text{m}$ )
- 3 = MI70 recharger adapter
- 4 = Pump on/off
- 5 = MI70 indicator
- 6 = Sample valve
- 7 = Sampling tube
- 8 = Sample gas inlet and outlet
- 9 = Flowmeter
- 10 = Detach this tube when sampling from pressurized processes.

## DSS70A Sampling Procedure

Make sure that the pump is switched off. Lift the flowmeter to a vertical position. Then follow the instructions below:

1. Close the sample valve by turning it clockwise as far as it goes.
2. If the process is not pressurized (600 ... 1200 mbar), continue from step 3. If the process is pressurized

(1.2 ... 20 bar), detach the flexible tube from the flowmeter. See Figure 25 on page 55.

3. Remove the inlet/outlet plugs.
4. Insert the 1/4" tubing into the **IN** fitting. Tighten the nut 1 1/4 turns with an open-ended, 14-mm spanner to make a gas-tight fitting. In future, only slight tightening with an open-ended spanner is needed to make a gas-tight fitting. Insert the tubing into the **OUT** fitting, if needed.
5. If the process is not pressurized, turn on the pump. If the process is pressurized, do not turn the pump on.
6. Adjust the sample flow using the sample valve, for example, 150 l/h = 2.5 l/min.
7. Turn on the MI70 indicator.
8. Set the pressure to represent the sample pressure. For details, see section Pressure Settings on page 36.
9. Wait until the reading has stabilized.
10. After the measurements, turn off the pump, remove the tubes, and put the inlet/outlet plugs back into their places.

**CAUTION**

Be careful when taking samples from hot processes. Do not touch the hot sampling lines without suitable protective clothing.

**NOTE**

The measured dewpoints must always be lower than the ambient temperature or DSS70A probe temperature to avoid condensation in the system. If condensation occurs, stop sampling and dry the system by circulating ambient air in the system.

Prevent liquids from entering the DSS70A sampling line as this may damage the product.

## DSS70A Maintenance

### Recharging the Battery

The battery must be recharged when the charger meter shows 10.5 V or less. DSS70A is powered by a battery, fitted underneath the system. MI70 uses its own battery when it is connected to DSS70A.



1. Detach the MI70 recharger adapter from the socket of the sampling system and plug in the recharger provided with DM70.
2. Disconnect the recharger when the battery is full and put the MI70 recharger back into the case.

If you want to recharge the sampling system and MI70 at the same time, connect the MI70 recharger adapter to the recharger socket on top of MI70 and recharge DSS70A as described above.

## Changing the Battery

Replacement batteries can be ordered from Vaisala (see section Accessories on page 89).

1. The battery is fitted underneath the sampling system. To change the battery, lift the sampling system from the briefcase. To lift the system, use two screwdrivers as lever arms and lift the system from two corners. See Figure 26 on page 57.



0403-049

**Figure 26 Lifting the System**

2. Turn the sampling system upside down. See Figure 27 below.

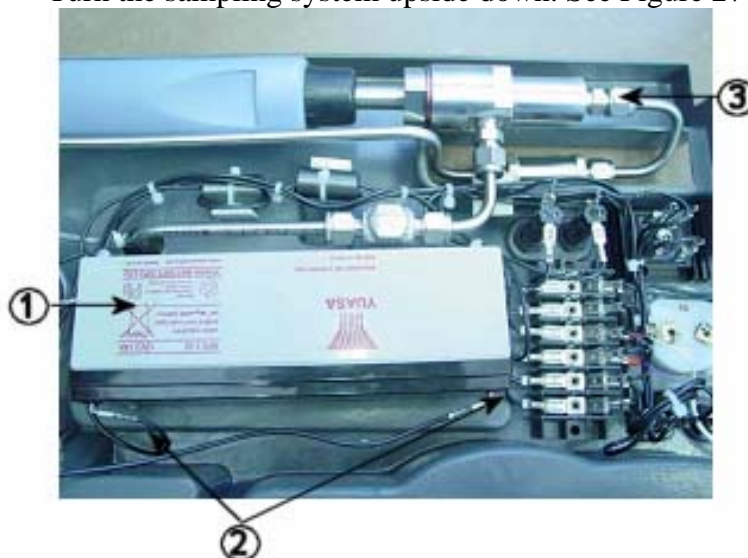

0403-050

**Figure 27 Sampling System Upside Down**

The following numbers refer to Figure 27 above.

- 1 = Battery
- 2 = Battery wires
- 3 = Nut of the sample cell

3. Detach the battery wires. Remove the old battery by pulling it up. The battery is attached to its place with double-sided tape.

**NOTE** The used battery must be disposed of according to the local laws and regulations.

4. Attach the double-sided tapes provided with the battery to the new battery enclosure. Place them onto the side without text. For reference, see the old battery.

**WARNING** Batteries are electrochemically live at all times. Do not short-circuit them.

5. Reconnect the wires as follows:  
 Red pole: BA + wire  
 Black pole: BA - wire
6. Press the new battery onto the tapes.

7. Put the system back into the briefcase.

## Changing the Filter

The filter should be changed regularly as a part of maintenance. However, the need for changing the filter depends on how dirty the process is. The filter may need to be changed after several hundreds of hours or after years. A dry filter may cause increased response times. A new filter can be ordered from Vaisala (see section Accessories on page 89).

1. To change the filter, lift the sampling system out of the briefcase. See Figure 26 on page 57.
2. Unscrew the nut of sample cell. See Figure 28 on page 59.
3. Turn the sampling cell right side up again and undo the nut of the filter cell.
4. Replace the filter and tighten the nuts. The direction of the arrow on the filter must match the direction of the arrow on DSS70A. See Figure 28 below.
5. Put the sampling system back into the briefcase.

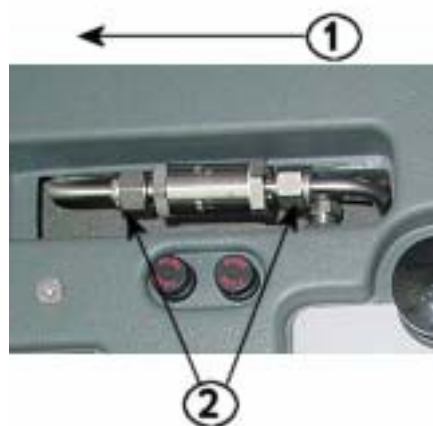

0403-051

**Figure 28** Changing the Filter

The following numbers refer to Figure 28 above.

- 1 = Filter direction
- 2 = Nuts of the filter

## **Changing the Fuses**

Press down the fuse button and simultaneously turn it. Replace the old fuse with a new one of same type and rating (glass tube fuse 5 x 20 mm T 2 A/250 VAC). Put the fuse button back into place by pressing and turning it.

## CHAPTER 8

# MEASURING MOISTURE IN SF<sub>6</sub> GAS-INSULATED EQUIPMENT

## Overview

Sulfur Hexafluoride (SF<sub>6</sub>) is an inert, insulating gas of high dielectric strength and thermal stability. SF<sub>6</sub> is used to insulate high voltage lines, circuit breakers, and other equipment used in transmission and distribution of electricity. Measuring moisture is crucial for the maintenance of SF<sub>6</sub> equipment.

The DMP74C probe has been optimized for measurements in SF<sub>6</sub> gas. The measurement is recommended to be made in pressurized gas for better dewpoint accuracy. The sensor purge feature of the DRYCAP® 180M allows a fast response in low dewpoints, and only a small amount of SF<sub>6</sub> needs to be drained from the GIE.

SF<sub>6</sub> is a greenhouse gas, with a global warming potential 24900 times that of CO<sub>2</sub>. For this reason, the gas should be recycled according to the local laws and regulations. The DSC74B sampling cell allows the gas to be collected after the measurement, see Figure 29 on page 62. When measurement is done in the GIE pressure, the structure of DSC74B eliminates the adverse effect of pressure fluctuation caused by the collection system.

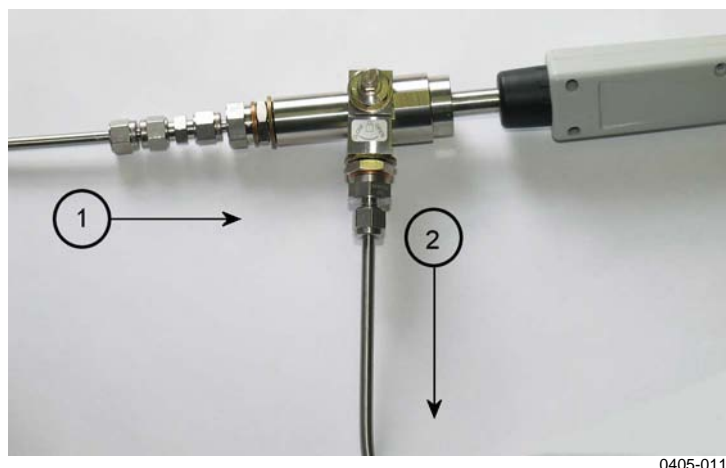

**Figure 29** Gas Collection Option

The following numbers refer to Figure 29 above.

- 1 = Gas from GIE
- 2 = Gas to the collecting system

## Operating Environment

A typical dewpoint of pure SF<sub>6</sub> is usually around -60 °C. The recommendations for the moisture limit of the equipment insulated with gas (GIE) vary between 70 ... 810 ppm<sub>v</sub>, which corresponds to -45 ... -22 °C T<sub>d/f</sub> in the atmospheric pressure, or -29 ... -3 °C T<sub>d/f</sub> in 5 bar<sub>g</sub> pressure. DM70 is able to measure the dewpoint directly in the GIE pressure (usually 3 ... 8 bar<sub>g</sub>), or the gas can be sampled and measured in the atmospheric pressure. If there is a need to measure high-pressure gas (>10 bar), for example in the recycling bottle, a regulator should be used to drop the pressure before the measurement.

High-voltage equipment can locate either indoors or outdoors. The operational temperature range of DM70 is between -10 ... +60 °C.

## Measuring

### CAUTION

Before measuring moisture, make sure that hydrofluoric (HF) acid is not present in the GIE.

With DSC74B, the dewpoint can be measured at the GIE pressure. If the measurement is done in the GIE pressure, DM70 is able to show the corresponding dewpoint in the atmospheric pressure.

DSC74B limits the flow rate with a leakage screw. The flow rate is optimized for GIE pressures between 3 ... 10 bar<sub>g</sub>, and no external flow meter is needed. The maximum flow can also be increased by removing the leak screw and adjusting the flow manually with the valve. To remove the leak screw, see Figure 30 below.



0405-012

**Figure 30**     **Removing the Leak Screw**

Parts per million by volume (ppm<sub>v</sub>) and parts per million by weight (ppm<sub>w</sub>) are frequently used to indicate humidity. The latter depends on the molecular weight of the gas. For SF<sub>6</sub>, the molecular weight is 146.06, and the conversion between ppm<sub>v</sub> and ppm<sub>w</sub> is the following:

$$\text{ppm}_w = \text{ppm}_v / 8.1$$

DM70 is able to show the ppm<sub>v</sub> and ppm<sub>w</sub> values for moisture.

This page intentionally left blank.



## CHAPTER 9

# CALIBRATION, ADJUSTMENT, AND MAINTENANCE

## Calibration

DM70 is fully calibrated and adjusted as shipped from the factory. The typical calibration interval is one year. Calibration must always be done when there is reason to believe that the device is not within the accuracy specifications.

The device can be sent to a Vaisala Service Center for calibration and adjustment, see contact information in section Vaisala Service Centers on page 78.

## User Calibration and Adjustment

In this User's Guide the term "calibration" refers to comparing the device's reading against a reference value. "Adjustment" refers to changing the device's reading to correspond to the reference value. After the adjustment, the original calibration certificate shipped with the product is no longer valid. Read the instructions through carefully before making any adjustments.

**NOTE**

Dewpoint calibration should be carried out in Vaisala or in other laboratory conditions.

## Adjusting DM70

The reference condition of the dewpoint must be traceable to the appropriate standards. The user adjustment requires a stable humidity generator capable of producing the required humidities and a calibrated reference dewpoint meter. For adjustment, the probe and the reference dewpoint meter are connected to the humidity generator output, the reference condition is adjusted and let to stabilize. After the probe and the reference dewpoint meter are stabilized, the DM70 reading is adjusted to correspond the reference value.

For the adjustment of the DMP74A probe, the dewpoint reference temperature should be between  $-40\text{ }^{\circ}\text{C}$  and  $-60\text{ }^{\circ}\text{C}$  ( $-40\text{ }^{\circ}\text{F}$  ...  $-76\text{ }^{\circ}\text{F}$ ), and for the DM74B and DMP74C probes, the dewpoint reference temperature should be between  $-57\text{ }^{\circ}\text{C}$  and  $-67\text{ }^{\circ}\text{C}$  ( $-70.6\text{ }^{\circ}\text{F}$  ...  $-88.6\text{ }^{\circ}\text{F}$ ). The optional sampling cell DSC74 (see Figure 20 on page 48) can be used as a calibration chamber to be connected with a humidity generator.

To ensure the correctness of the adjustment, the reference dewpoint meter must be calibrated at a recognized laboratory with a known uncertainty and traceability to national or international standards

The  $T_d$  and  $H_2O$  parameters can be viewed in the adjustment mode to see the effect of the adjustment.

To see when the adjustment was made last, select **Last adjustment date** or check the date from the **Device information** (see section Device Information on page 41).

## Adjusting DMT340 Series Transmitters Using DM70 as Reference or Terminal

Vaisala DRYCAP<sup>®</sup> Dewpoint and Temperature Transmitter Series DMT340 can be adjusted using a correctly adjusted DM70 as a reference dewpoint meter. Note that dewpoint adjustment should be carried out in laboratory conditions and not in the field. The adjustment procedure for DMT340 using DM70 as a reference is very similar to the adjustment of the DMP74B/C probes. You can also use the MI70 indicator without the reference probe as a terminal to display the measurement readings and to control the adjustment functions when making adjustment of DMT340. This is especially useful with transmitters without display. Instructions are provided in section Td/f Adjustment of DMT340 Series Transmitters using DM70 on page 71.

## Adjusting Dewpoint

Before adjusting dewpoint, first carry out the two-point, relative humidity calibration, which will ensure the basic adjustment level. When adjusting the DMP74B or DMP74C probe or DMT340 series transmitters with the M-sensor, do the sensor purge before calibration and adjustment. For details, see section Sensor Purge on page 29.

## Two-Point Relative Humidity Adjustment

### NOTE





For probes DMP74A, the wet point humidity reference must be >20 %RH.

For probes DMP74B and DMP74C, the wet point humidity reference must be <20 %RH.

For DMP74A, the humidity references of 0 % (for example Nitrogen) and 30 ... 75 % are recommended. Make sure that the difference between the humidity references is more than 30 %.

For DMP74B and DMP74C, the humidity references of 0 % (for example Nitrogen) and 11 % are recommended.

To make the adjustment, follow the instructions below:

1. Check that DM70 is turned on.
2. When using the DMP74B probe, do the manual sensor purge. For details, see section Manual Sensor Purge on page 31.
3. Unscrew the screw from the probe handle to expose the calibration button (see number 4 in Figure 1 on page 11). Then press the button with a small screwdriver. When pressing the button, the indicator switches into the adjustment mode.
4. To start adjusting, press  **OK**.
5. Then select **RH** and press .
6. To check the environmental settings, press  **Yes**. To continue without checking the settings, press  **No**.

7. To select the adjustment method, press **⊖ Adjust**.
8. Select **2-point adjustment** and press **⊖ Select**. Then press **⊖ OK** to continue.
9. Set the probe to a lower reference value of relative humidity <sup>1)</sup>. You can follow the stabilization from the graph display by pressing **⊖ Graph**. When the reading has stabilized, press **⊖ Ready**.
10. Use the arrow buttons to give the lower reference value of relative humidity. Then press **⊖ OK**.
11. Set the probe to a higher reference value of relative humidity <sup>1)</sup>. When the reading has stabilized, press **⊖ Ready**. You can follow the stabilization from the graph display by pressing **⊖ Graph**.
12. Use arrow buttons to give the higher reference value of relative humidity. Then press **⊖ OK**.
13. Confirm the adjustment by pressing **⊖ Yes**. If you press **⊖ No**, the adjustment display returns and no changes are made.

**NOTE**

DMP74A: If the difference between the two references is less than 30 %, the adjustment cannot be done.

14. Now the adjustment is completed. To exit the adjustment mode, press **⊖ Back**.
15. To return to the basic display, press **⊖ Exit**.
16. If you do not continue with the dewpoint adjustment, place the screw back onto the calibration button.

1) If there is a temperature difference between the generated reference and the probe temperature, relative humidity must be calculated to correspond to the temperature of the probe.

## Two-Point Relative Humidity Adjustment of DMT340 Series Transmitters Using DM70

DM70 can be used for making the two-point relative humidity adjustment of DMT340 series transmitters.

For DMT340 M-sensor, humidity references of 0 % (for example Nitrogen) and 10 ... 20 % are required.

**NOTE**

For the DMT340 M-sensor both reference humidities must be below 20 %RH.

To make the adjustment, follow the instructions below:

1. Turn off DM70.
2. Connect the cable 211339 between DMT340 (service port) and DM70 (connector I or II). Turn on both the devices.
3. With DMT340 series transmitters with the M-sensor, perform the manual purge. Also, if you are using DMP74B probe as reference, perform the manual purge on the reference probe as well.
4. Press the ADJ button on the DMT340 motherboard to enable the adjustment mode.
5. From the list of parameters, select **RH<sub>I/II</sub>**
6. You are prompted to check the settings, make sure that the pressure units of DM70 and DMT340 are the same. If not, change the unit by pressing **⊖ Unit** on the corresponding row.
7. Continue with the adjustment by pressing **⊖ Adjust**. Select **2-point adjustment**. A note is displayed on the screen reminding you to follow the adjustment procedure described in the User's Guide. Press **⊖ OK** to proceed with the adjustment.
8. Set the probe to a lower reference value of relative humidity <sup>1)</sup>. You can follow the stabilization from the graph display by pressing **⊖ Graph**. When the reading has stabilized, press **⊖ Ready**.
9. Use the arrow buttons to give the lower reference value of relative humidity. Then press **⊖ OK**.
10. Set the probe to a higher reference value of relative humidity <sup>1)</sup>. When the reading has stabilized, press **⊖ Ready**. You can follow the stabilization from the graph display by pressing **⊖ Graph**.
11. Use arrow buttons to give the higher reference value of relative humidity. Then press **⊖ OK**.

12. Confirm the adjustment by pressing  $\ominus$  **Yes**. If you press  $\ominus$  **No**, the adjustment display returns and no changes are made.
  13. Now the adjustment is completed. To exit the adjustment mode, press  $\ominus$  **Back**.
  14. To return to the basic display, press  $\ominus$  **Exit**.
- 1) If there is a temperature difference between the generated reference and the probe temperature, relative humidity must be calculated to correspond to the temperature of the probe.

## Adjusting Dewpoint $T_{d/f}$

### NOTE

For DMP74B/C, the sensor purge must be performed manually one hour before adjusting the dewpoint.

### $T_{d/f}$ Adjustment of DM70

For DMP74A, the reference temperature of the dewpoint should be -40 °C ... -60 °C (-40 °F ... -76 °F).

For DMP74B/C, the reference temperature of the dewpoint should be -57 °C ... -67 °C (-70.6 °F ... -88.6 °F).

To adjust the dewpoint, follow the instructions below:

1. Set the probe to the reference condition. Follow the stabilization from the graphic display by pressing  $\ominus$  **Graph**. The minimum recommended stabilization time for this critical adjustment is 5 hours.
2. Perform the manual purge if necessary.
3. Press the **Calibration** button of the probe handle (see number 4 in Figure 1 on page 11) using a tool with a thin, sharp point, for example, a small screwdriver. The indicator will switch into the adjustment mode. To confirm calibration, press  $\ominus$  **OK**.
4. Select  $T_{d/f}$  and press  $\ominus$  **Select**.
5. To check the environmental settings, press  $\ominus$  **Yes**. To go to calibration directly, press  $\ominus$  **No**.

6. To select **1-point adjustment**, press  $\ominus$  **Adjust** and then  $\ominus$  **Select**.
7. When the reading has stabilized at the reference level, press  $\ominus$  **Ready**.
8. Use the arrow buttons to give the reference value. Then press  $\ominus$  **OK**.
9. Confirm the adjustment by pressing  $\ominus$  **Yes**. If you press  $\ominus$  **No**, the adjustment mode display returns and no changes are made.
10. Wait until the automatic auto-calibration has taken place.
11. When the calibration is completed, press  $\ominus$  **Back** to exit the adjustment mode.
12. To return to the basic display, press  $\ominus$  **Exit**.
13. Place the screw back onto the calibration button.
14. To seal the calibration, attach a sticker on the calibration button.

**NOTE**

Several AutoCals can be necessary after this adjustment has been performed until the transmitter reaches full accuracy.

### **T<sub>d/f</sub> Adjustment of DMT340 Series Transmitters using DM70**

**NOTE**

For DMT340 series transmitters with the M-sensor, the sensor purge must be performed manually one hour before adjusting the dewpoint.

For DMT340 series transmitters, the reference temperature of the dewpoint should be  $-57\text{ }^{\circ}\text{C} \dots -67\text{ }^{\circ}\text{C}$  ( $-70.6\text{ }^{\circ}\text{F} \dots -88.6\text{ }^{\circ}\text{F}$ ).

To make dewpoint adjustment of DMT340, follow the eight first steps below and then continue according to the chosen adjustment method:

1. Turn off DM70.
2. Connect the cable 211339 between DMT340 (service port) and DM70 (connector I or II). Turn on both the devices.
3. Set the probe to the reference condition. Follow the stabilization from the graphic display by pressing

- ⊖ **Graph**. The minimum recommended stabilization time for this critical adjustment is 5 hours.
4. Perform the manual purge if necessary.
  5. Press the ADJ button on the DMT340 motherboard to enable the adjustment mode.
  6. From the list of parameters, select **T<sub>d/f I/II</sub>**
  7. You are prompted to check the settings, make sure that the pressure units of DM70 and DMT340 are the same. If not, change the unit by pressing ⊖ **Unit** on the corresponding row.
  8. At this point you need to select the adjustment method. If the reference probe is connected, two options are displayed: **To same as T<sub>d/f I/II</sub>** or **1-point adjustment**.

If you are using DM70 as a terminal, only **1-point adjustment** is possible.

To Same as T<sub>d/f I/II</sub>

**NOTE**

This adjustment method automatically uses the reading of the reference probe as the reference value for making the adjustment.

9. Continue with the the adjustment by pressing ⊖ **Yes**.
10. A note is displayed on the screen reminding you to follow the adjustment procedure described in the User's Guide. Press ⊖ **OK** to proceed with the adjustment.
11. Follow the stabilization from the graphic display by pressing ⊖ **Graph**. The minimum recommended stabilization time for this critical adjustment is 5 hours.
12. When the reading has stabilized at the reference level, press ⊖ **Ready**. This adjustment method automatically uses the reading of the reference probe as the reference value.
13. Confirm the adjustment by pressing ⊖ **Yes**. If you press ⊖ **No**, the adjustment mode display returns and no changes are made.
14. Wait until the automatic auto-calibration has taken place.
15. When the calibration is completed, press ⊖ **Back** to exit the adjustment mode.
16. To return to the basic display, press ⊖ **Exit**.



17. Place the screw back onto the calibration button.
18. To seal the calibration, attach a sticker on the calibration button.









**NOTE**

Several AutoCals can be necessary after this adjustment has been performed until the transmitter reaches full accuracy.

### 1-Point Adjustment

**NOTE**

This adjustment method allows the customer to manually enter the reference value when making the adjustment.

9. A note is displayed on the screen reminding you to follow the adjustment procedure described in the User's Guide. Press  **OK** to proceed with the adjustment.
10. Follow the stabilization from the graphic display by pressing  **Graph**. The minimum recommended stabilization time for this critical adjustment is 5 hours.
11. When the reading has stabilized at the reference level, press  **Ready**.
12. Use the arrow buttons to give the reference value. Then press  **OK**.
13. Confirm the adjustment by pressing  **Yes**. If you press  **No**, the adjustment mode display returns and no changes are made.
14. Wait until the automatic auto-calibration has taken place.
15. When the calibration is completed, press  **Back** to exit the adjustment mode.
16. To return to the basic display, press  **Exit**.
17. Place the screw back onto the calibration button.
18. To seal the calibration, attach a sticker on the calibration button.

**NOTE**

Several AutoCals can be necessary after this adjustment has been performed until the transmitter reaches full accuracy.

# Adjusting Temperature

## Temperature Adjustment of DM70

The temperature adjustment can be done using the one-point or two-point adjustment. The one-point adjustment should be done within the temperature range in which the device is most often used.

To go to the adjustment mode, do the following:

1. Press the **Calibration** button of the probe handle (see number 4 in Figure 1 on page 11) using a tool with a thin, sharp point, for example, a small screwdriver. The indicator will switch into the adjustment mode. To confirm calibration, press **OK**.
2. Select **T<sub>diff</sub>** and press **Select**.
3. Select **T** and press **Select**.
4. To select the adjustment method, first press **Adjust** and then the adjustment method, either **1-point adjustment** or **2-point adjustment**.
5. Depending on your selection, continue from section One-Point Adjustment below or Two-Point Adjustment on page 75.

### One-Point Adjustment

1. After selecting **1-point adjustment**, press **Select** to continue.
2. Set the probe to the reference temperature. You can follow the stabilization from the graph display by pressing **Graph**. When the reading has stabilized, press **Ready**.
3. Use the arrow buttons to give the reference temperature value and then press **OK**.
4. Confirm the adjustment by pressing **Yes**. (If you press **No**, the adjustment mode display returns and no changes are made.) The adjustment has now been completed.
5. To exit the adjustment mode, press **Back**.
6. To return to the basic display, press **Exit**.

## Two-Point Adjustment

1. After selecting **2-point adjustment**, press **⊖ Select** to continue.
2. Set the probe to a lower reference temperature. You can follow the stabilization from the graphical display by pressing **⊖ Graph**. When the reading has stabilized, press **⊖ Ready**.
3. Use the arrow buttons to give the lower reference temperature value and then press **⊖ OK**.
4. Set the probe to a higher reference temperature. You can follow the stabilization from the graphical display by pressing **⊖ Graph**. When the reading has stabilized, press **⊖ Ready**.
5. Use the arrow buttons to give the higher reference temperature value and then press **⊖ OK**.
6. Confirm the adjustment by pressing **⊖ Yes**. (If you press **⊖ No**, the adjustment mode display returns and no changes are made.) The adjustment has been completed.

**NOTE**

If the difference between the two references is less than 30 °C, the adjustment cannot be done.

7. To exit the adjustment mode, press **⊖ Back**.
8. To return to the basic display, press **⊖ Exit**.

## Temperature Adjustment of DMT340 Series Using DM70

DM70 can be used for making the temperature adjustment of DMT340 series transmitters.

To make dewpoint adjustment of DMT340, follow the six first steps below and then continue according to the chosen adjustment method:

1. Turn off DM70.
2. Connect the cable 211339 between DMT340 (service port) and DM70 (connector I or II). Turn on both the devices.
3. Press the ADJ button on the DMT340 motherboard to enable the adjustment mode.

4. From the list of parameters, select **T<sub>I/II</sub>**
5. At this point you need to select the adjustment method. If the reference probe is connected, two options are displayed: **To same as T<sub>I/II</sub>**, **1-point adjustment** or **2-point adjustment**.
6. You are prompted to check the settings, make sure that the pressure units of DM70 and DMT340 are the same. If not, change the unit by pressing **⊖ Unit** on the corresponding row.

### To Same as T<sub>I/II</sub>

**NOTE**

This adjustment method automatically uses the reading of the reference probe as the reference value for making the adjustment.

7. After selecting **To same as T<sub>I/II</sub>**, confirm the adjustment by pressing **⊖ Yes**.

If you press **⊖ No**, a note is displayed on the screen reminding you to follow the adjustment procedure described in the User's Guide. Press **⊖ OK** and the adjustment mode display returns and no changes are made.

### 1-Point Adjustment

7. After selecting **1-point adjustment**, press **⊖ Select** to continue.
8. Set the probe to the reference temperature. You can follow the stabilization from the graph display by pressing **⊖ Graph**. When the reading has stabilized, press **⊖ Ready**.
9. Use the arrow buttons to give the reference temperature value and then press **⊖ OK**.
10. Confirm the adjustment by pressing **⊖ Yes**. (If you press **⊖ No**, the adjustment mode display returns and no changes are made.) The adjustment has now been completed.
11. To exit the adjustment mode, press **⊖ Back**.
12. To return to the basic display, press **⊖ Exit**.

## 2-Point Adjustment

7. After selecting **2-point adjustment**, press **⊖ Select** to continue.
8. Set the probe to a lower reference temperature. You can follow the stabilization from the graphical display by pressing **⊖ Graph**. When the reading has stabilized, press **⊖ Ready**.
9. Use the arrow buttons to give the lower reference temperature value and then press **⊖ OK**.
10. Set the probe to a higher reference temperature. You can follow the stabilization from the graphical display by pressing **⊖ Graph**. When the reading has stabilized, press **⊖ Ready**.
11. Use the arrow buttons to give the higher reference temperature value and then press **⊖ OK**.
12. Confirm the adjustment by pressing **⊖ Yes**. (If you press **⊖ No**, the adjustment mode display returns and no changes are made.) The adjustment has been completed.

**NOTE**

If the difference between the two references is less than 30 °C, the adjustment cannot be done.

13. To exit the adjustment mode, press **⊖ Back**.
14. To return to the basic display, press **⊖ Exit**.



## CHAPTER 10

# DE-COMMISSIONING, DISMANTLING, AND DISPOSAL

### **WARNING**

Contaminated parts can be detrimental to health and environment. Before beginning to work, find out whether any of the parts - especially the probe, filter, or sampling cell - have been contaminated (radioactive, toxic, caustic, or contains a biological hazard, etc.) during the measurement process.

Adhere to the relevant regulations and take the necessary precautions when handling contaminated parts.

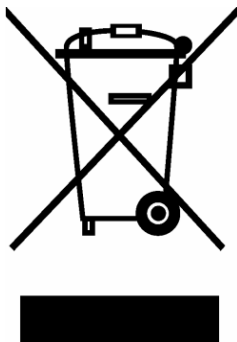

1. Contaminated components, if any, must be decontaminated according to the relevant national regulations.
2. The battery packs and/or alkaline batteries must be removed as described in section Installing and Removing the Battery Pack on page 13 (MI70) and in section Changing the Battery on page 57 (DSS70A).
3. Dismantled parts must be separated according to the materials and disposed of according to the local laws and regulations.

This page intentionally left blank.



## CHAPTER 11

# TECHNICAL SPECIFICATIONS

### Measured Variables

#### Dewpoint Temperature

##### Measurement range

DMP74A	-50 ... +60 °C (-58 ... +140 °F)
DMP74B	-70 ... +30°C (-94 ... +86 °F)
DMP74C	-70 ... +30°C (-94 ... +86 °F)

##### Accuracy

±2 °C (±3.6 °F), see Figure 31,  
Figure 32, and Figure 33 on page 82.

Dewpoint range for ±2 °C. Accuracy for pressure converted dewpoint  
(dewpoint measured in pressure, calculated to 1 atm dewpoint value)

DMP74A	-64 ... +60 °C (-83 ... 140 °F)
DMP74B	-80 ... +20 °C (-112 ... 68 °F)
DMP74C	-72 ... +20 °C (-98 ... 68 °F)

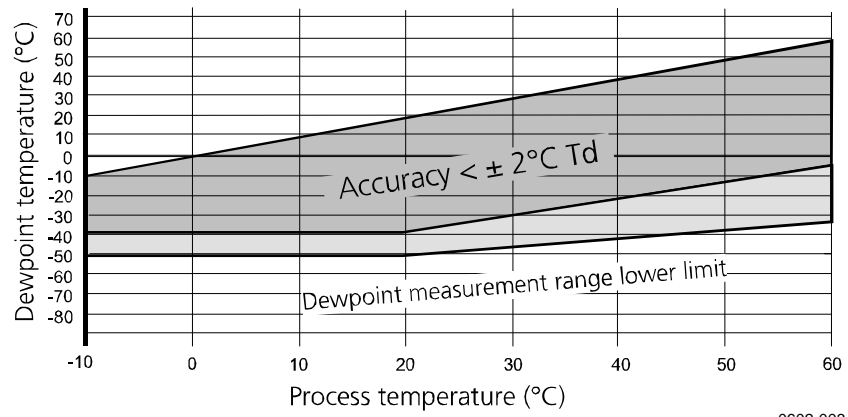

**Figure 31 DMP74A Accuracy**

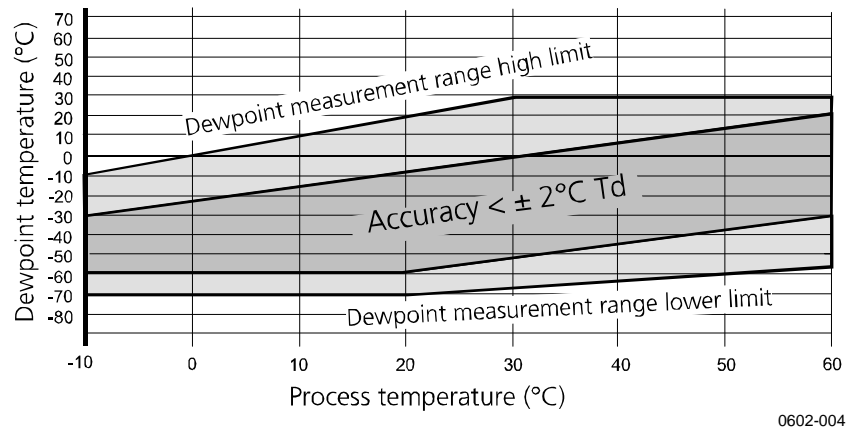

**Figure 32 DMP74B Accuracy**

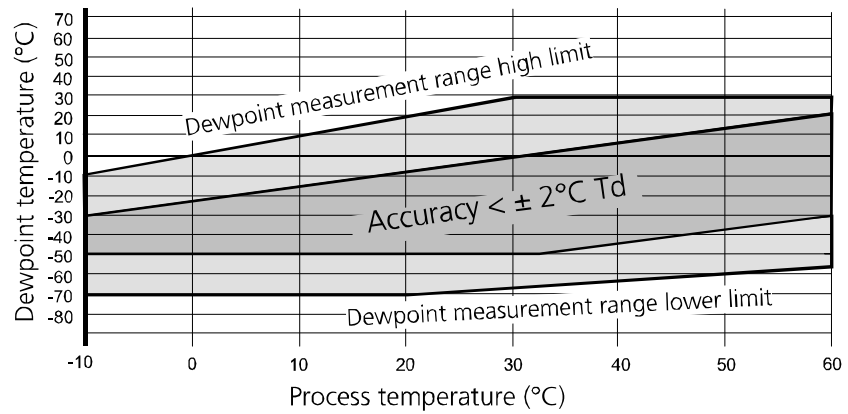

**Figure 33 DMP74C Accuracy**

**DMP74A**

Response time: 63 % (90 %) at flow rate 0.2 m/s, 1 bar  
absolute pressure, +20 °C

0 → -40 °C T <sub>d</sub> (32 → 40 °F T <sub>d</sub> )	20 s	(120 s)
-40 → 0 °C T <sub>d</sub> (-40 → 32 °F T <sub>d</sub> )	10 s	(20 s)

**DMP74B/C**

Response time: 63 % (90 %) at flow rate 0.2 m/s, 1 bar  
absolute pressure, +20 °C

0 → -60 °C T <sub>d</sub> (32 → 76 °F T <sub>d</sub> )	50 s	(340 s)
-60 → 0 °C T <sub>d</sub> (-76 → 32 °F T <sub>d</sub> )	10 s	(20 s)

**Temperature**

Measurement range	-10 ... 60 °C (14 ... 140 °F)
Accuracy at +20 °C	±0.2 °C (±0.36 °F)
Typical temperature dependence of electronics	±0.005 °C/°C
Temperature sensor	Pt100 IEC751 1/3 class B

**PPM (ppm<sub>v</sub> or ppm<sub>w</sub>)**

Measurement range (typical)	
DMP74A	40 ... 200000 ppm
DMP74B/C	10 ... 20000 ppm
Accuracy at +20 °C (+68 °F)	
< 40 ppm	± (0.5 ppm + 25.4 % of reading)
> 40 ppm	± (7.3 ppm + 8.3 % of reading)

**Absolute Humidity (DMP74A Probe Recommended)**

Measurement range (typical)	0.5 ... 100 g/m <sup>3</sup> (0.2 ... 40 gr/ft <sup>3</sup> )
Accuracy	± (0.2 g/m <sup>3</sup> + 10 % of reading) ± (0.1 gr/ft <sup>3</sup> + 10 % of reading)

**Mixing Ratio (DMP74A Probe Recommended)**

Measurement range (typical)	0.2 ... 100 g/kg (2 ... 700 gr/lbs)
Accuracy	± (0.1 g/kg + 12 % of reading) ± (0.8 gr/lbs + 12 % of reading)

**Relative Humidity (DMP74A)**

Measurement range	0 ... 100 %
Accuracy at +20 °C	
RH < 5 %	± (0.025 % RH + 17.5 % of reading)
RH > 5 %	± (0.8 % RH + 2 % of reading)

**Measurement Environment**

Temperature	-10 ... +60 °C (+14 ... +140 °F)
Pressure	
DMP74A	0 ... 20 bar <sub>a</sub> (0 ... 290 psi <sub>a</sub> )
DMP74B	0 ... 20 bar <sub>a</sub> (0 ... 290 psi <sub>a</sub> )
DMP74C	0 ... 10 bar <sub>a</sub> (0 ... 150 psi <sub>a</sub> )
Sample flow rate	No effect on the dewpoint accuracy

## Probe General

Sensor	DMP74A DMP74B/C	Vaisala DRYCAP® 180S Vaisala DRYCAP® 180M
Probe material (wetted parts)		Stainless steel (AISI 316L)
Sensor protection		Sintered filter, (AISI 316L), part No. HM47280SP
Mechanical connection		G1/2" ISO2281 thread with bonded seal ring (U-seal)
Housing classification		IP65 (NEMA4)
Storage temperature		-40 ... +70 °C
Storage humidity		0 ... 100 % RH non- condensing
Weight		350 g

## MI70 Indicator

### Indicator General

Operating temperature range	-10 ... +40 °C (+14 ... +104 °F)
Operating humidity	non-condensing
Menu languages	English, Finnish, French, German, Spanish, Chinese, Russian, Japanese and Swedish
Display	LCD with backlight Graphic trend display of any quantity Character height up to 16 mm
Probe inputs	1 or 2
Power supply	Rechargeable NIMH battery pack with AC power or 4 x AA size alkalines, type IEC LR6

Analog output	0 ... 1 VDC
Output resolution	0.6 mV
Accuracy	0.2 % full scale
Temperature dependence	0.002 %/°C full scale
Minimum load resistor	10 kohm to ground
Data interface	RS232C (EIA-232)
Data logging capacity	900 ... 2700 real time data points
Logging interval	1 s to 12 h
Logging duration	1 min ... memory full
Alarm	Audible alarm function
Housing classification	IP54
Weight	400 g

### Battery Pack

Operation times in	
continuous use	48 h typical at +20 °C
data logging use	up to 30 days
Power consumption during charge	10 W max
Charging time	4 hours

## DMP74 Probe + MI70 Indicator = Vaisala DRYCAP<sup>®</sup> DM70 Hand-Held Dewpoint Meter

### General

Storage temperature	-40 ... +70 °C (-40 ... +158 °F)
Storage humidity range	0 ... 100 % non-condensing
Housing material	ABS/PC blend
Total weight	750 g

## Electromagnetic Compatibility

Complies with the following standard: EN61326-1:1997 +Am 1:1998, Electrical equipment for measurement, control, and laboratory use - EMC requirements: Generic environment.

## Sampling Cells

### DMT242SC Sampling Cell

Inlet/outlet thread	ISO G 3/8"/G 1/4"
Pressure limit	10 MPa, 100 bar <sub>g</sub> , 1450 psi <sub>g</sub>
Material	Stainless steel AISI316
Weight	220 g

### DMT242SC2 Sampling Cell with Swagelok Connectors

Inlet/outlet thread	1/4" Swagelok connectors (for 1/4" tubing)
Pressure limit	4 MPa, 40 bar <sub>g</sub> , 580 psi <sub>g</sub>
Material	Stainless steel AISI316
Weight	285 g

### DSC74 Sampling Cell for Pressurized Gases

Quick connector	Type D/NIP08
Leak screw	Screwdriver operated
Inlet/outlet thread	ISO G 3/8"/G 1/4"
Thread adapters included	a) ISO G 3/8" to G 1/4" (female) B) ISO G 3/8" to G 1/2" (male)
Pressure limit	1 MPa, 10 bar <sub>g</sub> , 145 psi <sub>g</sub>
Material	Stainless steel AISI316
Weight	300 g

### DSC74B Two-Pressure Sampling Cell

Inlet/outlet thread	ISO G 3/8"/G 3/8"
Flow adjustment	Manually operated
Pressure limit	1 MPa, 10 bar <sub>g</sub> , 145 psi <sub>g</sub>

Material	Stainless steel AISI316
Weight	390 g

### DSC74C

DSC74C is a sampling cell with DSC74B with DMCOIL cooling/venting coil.

### DMCOIL

Coil pipe size	6 mm
Connection to sampling cell	With ISO G 1/4" and G 3/8" thread adapter
Weight	130 g

## DSS70A Sampling System

Measuring range	-60 °C $T_d$ ... $T_{amb}$ (max $T_{amb}$ +40 °C $T_d$ )
Operating gases	Air, N <sub>2</sub> , non-toxic gases, non-flammable, inert gases
Inlet/Outlet connection	1/4" SWAGELOK
Operating temperature	
Ambient temperature	0 ... +40 °C (+32 ... +104 °F)
Gas temperature	max 200 °C (392 °F) with 2.0 m FEP tube at 20 °C (68 °F)
Operating pressure	
with pump	0.6 ... 1.2 bar <sub>a</sub> (8.7 ... 17.4 psi <sub>a</sub> )
pump disconnected	0 ... 20 bar <sub>a</sub> (0 ... 290 psi <sub>a</sub> )
Battery operation time for pump	8 h continuous
Filter	7 mm inline filter, 1/4" SWAGELOK SS-4F-7
Wetted parts	Stainless steel
Carrying case	ABC plastic
Weight	5.5 kg (12 lbs.)



Fuse ratings

Glass tube fuse 5x20 mm T  
2A/250 VAC (Manufacturer:  
Littlefuse 218002)

## Accessories

**Table 2 List of Accessories**

Description	Order Code
<b>AC Adapters</b>	
Euro AC adapter	MI70EUROADAPTER
UK AC adapter	MI70UKADAPTER
US AC adapter	MI70USADAPTER
AUS AC adapter	MI70AUSADAPTER
MI70 All adapter	MI70ALLADAPTER
<b>Sampling</b>	
Sampling cell	DMT242SC
Sampling cell with Swagelok connectors	DMT242SC2
Sampling cell for pressurized gases	DSC74
Two pressure sampling cell	DSC74B
Two pressure sampling cell with venting coil	DSC74C
Cooling/venting coil for sampling cells	DMCOIL
<b>Cables</b>	
Analog output signal cable	27168ZZ
Connection cable for DMP248	27159ZZ
Connection cable for DMT142	211917ZZ
Connection cable for DMT242	27160ZZ
Probe extension table (10 m)	213107SP
Connection cable for DMT340	211339
<b>Carrying cases</b>	
Plastic case	MI70CASE
Aluminum case	MI70CASE2
<b>Probe accessories</b>	
Sintered filter for the probe	HM47280SP
Bonded seal ring	26230
<b>Others</b>	
Measurement indicator	MI70
MI70 Link software interface kit	MI70LINK
Filter for DSS70A	210801
Rechargeable battery for MI70	26755
Rechargeable battery for DSS70A	DSS70BAT
Service kit for DSC74 (all versions)	DSC74SERVICEKIT
<b>PC Connection tools</b>	
MI70 Link software interface kit including a USB instrument cable for MI70	219687
MI70 Link software interface kit including a serial connection cable for MI70	MI70LINK

## Dimensions

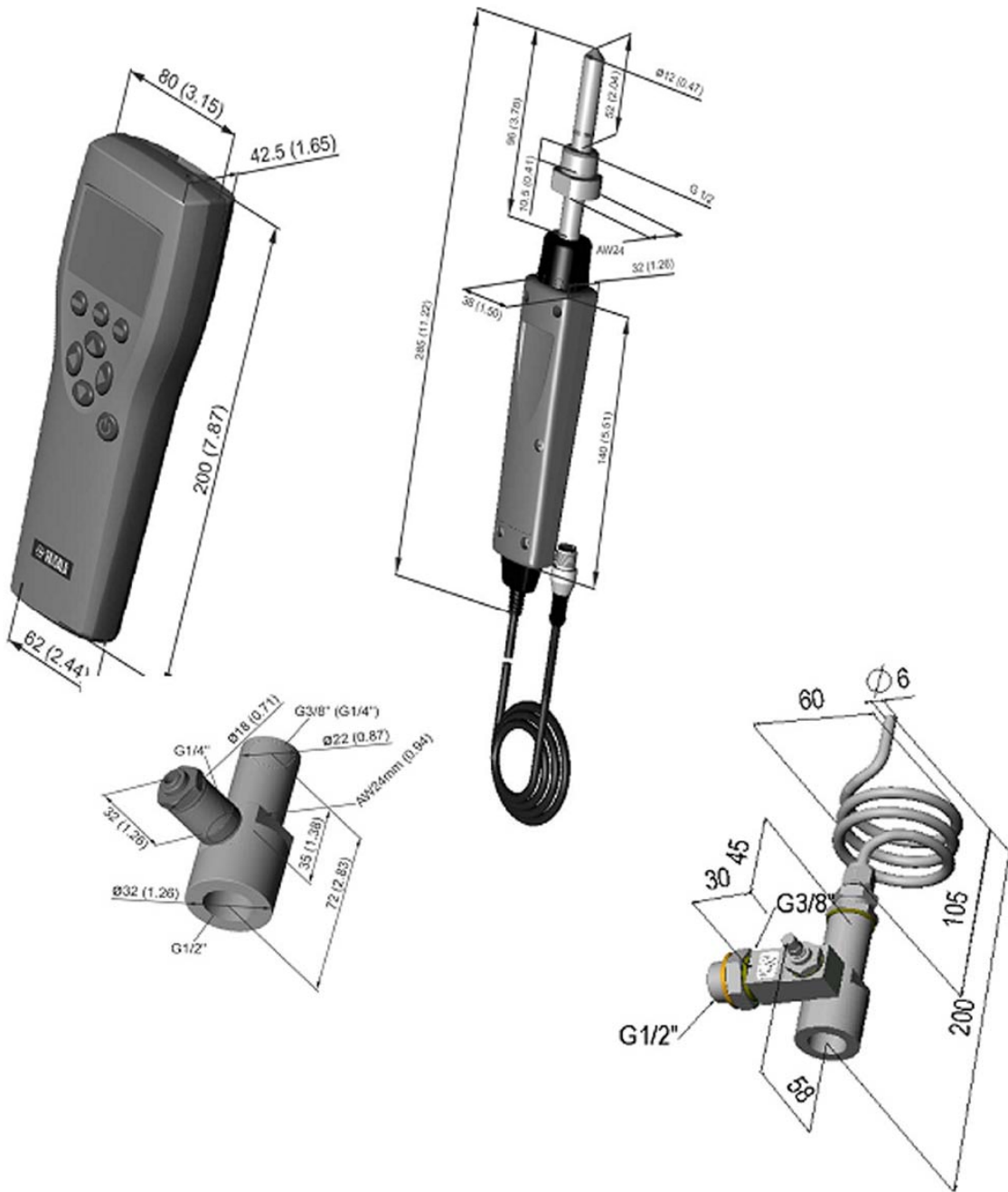

0403-055

**Figure 34** Dimensions in Millimeters (Inches)

**W**

Warranty

8

**上海博众测量技术有限公司**

Bodhi (Shanghai) measurement technology Co.,Ltd.  
NO.32,ShuPing Road, JiadingDistrict,ZIP201808,  
Shanghai R.P.China  
TEL: 0086 21 6630 8161/62/63  
FAX: 0086 21 6630 8167

[www.bodhi-mt.com](http://www.bodhi-mt.com)

